

Instruction Manual

Flow Measurement Transmitter NivuFlow 600 / NivuFlow 600 WS



Firmware Revision: 4.1.x

Revised Instruction Manual

Document Revision: Rev. 04 / 16.01.2024

Original Instruction Manual: German / Rev. 04 / 24.11.2023

measure analyse optimise

NIVUS AG, Switzerland

Burgstrasse 28
8750 Glarus, Switzerland
Phone +41 55 6452066
Fax +41 55 6452014
swiss@nivus.com
www.nivus.de

NIVUS Middle East (FZE)

Prime Tower
Business Bay Dubai
31st floor, office C-3
P.O. Box: 112037
Phone +971 4 4580502
middle-east@nivus.com
www.nivus.com

NIVUS, Austria

Mühlbergstraße 33B
3382 Loosdorf, Austria
Phone +43 2754 5676321
Fax +43 2754 5676320
austria@nivus.com
www.nivus.de

NIVUS Korea Co. Ltd.

#2301 M Dong Technopark IT Center,
32 Songdogwahak-ro, Yeonsu-gu,
INCHEON, Korea 21984
Phone +82 32 2098588
Fax +82 32 2098590
jhwon@nivuskorea.com
www.nivuskorea.com

NIVUS Sp. z o.o., Poland

ul. Hutnicza 3 / B-18
81-212 Gdynia, Poland
Phone +48 58 7602015
Fax +48 58 7602014
biuro@nivus.pl
www.nivus.pl

NIVUS Vietnam

238/78 Phan Trung Street,
Tan Tien Ward, Bin Hoa City,
Dong Nai Province, Vietnam
Phone +84 94 2623979
jhwon@nivuskorea.com
www.nivus.com

NIVUS, France

12 rue Principale
67870 Bischoffsheim, France
Phone +33 388 999284
info@nivus.fr
www.nivus.fr

NIVUS Ltd., United Kingdom

Furzen Hill Farm
Coventry Road, Cubbington
Royal Leamington Spa
CV32 7UJ, Warwickshire
Phone +44 8445 332883
nivusUK@nivus.com
www.nivus.com

Copyrights and Property Rights

The contents of this document including tables and drawings are proprietary to NIVUS GmbH and are not to be reproduced or copied without express written permission.

Violations oblige to compensation.



Important Notice

This instruction manual - even in parts - may exclusively be copied or translated in any other way with the express written consent of NIVUS GmbH.

Translation

If the device is sold to a country in the European Economic Area the description must be translated into the language of the country in which the device is to be used.

Should the translated text be unclear, the original instruction manual (German) must be consulted or a member company of the NIVUS group must be contacted for clarification.

Copyright

No part of this publication may be reproduced, transmitted, sold or disclosed without prior permission. All rights reserved.

Names

The use of general descriptive names, trade names, trademarks and the like in this manual does not entitle the reader to assume they may be used freely by everyone. They are often protected registered trademarks even if not marked as such.

Revision History

Rev.	Modifications	Editor	Date
04	<p>Transmitter NivuFlow 600 WS included; addresses updated; Chap. "1 About this Manual", "2.3 Tasks of the control elements", "2.4 Interfaces" and "7 Intended Use" updated; Chap. "8 Ex Protection" added; Chap. "9 Duties of the Operator", "11 Scope of Delivery", "15 Return", "16 Product Construction and Overview", "17 Specifications" and "18.1 Device Versions" updated; Chap. "18.2 Add-On Function Licences" added; Chap. "19 Areas of Use", "21.5 Fastening the field enclosure and preparations for electrical installation" and "22.2 Terminal Wiring Diagrams" updated, Fig. 22-9 changed; Chap. "22.3.2 Power Supply AC" updated; Chap. "23.6.1 Sensor connection with 1-path measurement / 2-path measurement": Cable Lengths for Clamp-On Sensors adapted; Chap. "23.7 Connection using NFE Extension Modules" supplemented; Chap. "24 Controller Mode (function can be added via licence)" added; Chap. "25 Overvoltage Protection Measures" and "25.4.2 Extended Protection - Overvoltage Protection "SonicPro T"" supplemented; Chap. "30 Parameterisation of a diametral 1-path Measurement" updated; Chap. "Commissioning": Information on Hold Symbol added; Chap. "Main Screen" updated and moved further forward in the overall structure; Chap. "33.2.5 Menu - Display", "34.1.7 (Medium) Temperature" and "34.2 Setting the Parameters in the Measurement Place Menu of the Combi Measurement Place" updated; Chap. "34.3.5 Serial number", "34.3.7 Mounting Support (only for NIS-V200R and NIS0V200RL)" and "34.3.11 Offset (Difference)" added; Chap. "34.2 Setting the Parameters in the Measurement Place Menu of the Combi Measurement Place" and "34.4 Setting Parameters in the Inputs and Outputs Menu (analogue and digital)" supplemented, Chap. "34.5 Setting Parameters of the Flow Controller (Q-Controller) (function can be added via licence)" added; Chap. "35.4 USB Stick" and "35.5 Data Memory (Internal)" updated; Chap. "35.5.2 Cycle Mode / Clock Control (function can be added via licence)" added; Chap. "36.3 Time/Date" and "36.4 Error Messages" updated; Chap. "36.5.3 Feature Unlock" and "36.5.7 Disable Coin Cell (Backup Battery)" added; Chap. "37.1 TCP/IP" and "37.2 Web Server" updated; Chap. "37.3 Data Transmission" and "37.4 Alarm" added; Chap. "37.4 Alarm" updated; Chap. "37.5 Modbus", "38 Parameter Menu Display" and "39 Parameter Menu Connections" supplemented; Chap. "42.4 Digital Outputs" updated; Chap. "43 Diagnostics Flow Controller (Q-Controller) (function can be added via licence)" added; Chap. "49 Dismantling/Disposal" and "51 Accessories" extended; Chap. "Index" and "Approvals and Certificates" updated; various minor changes to text, images and layout</p>	MoG	16.01.2024
03	Complete revision: addition of various features and functions, layout modifications etc.	MoG	22.10.2019
02	Chap. "33.4 Alignment" changed	MoG	27.02.2019
01	Minor changes without approval	DMR	25.04.2016
00	New Creation	DMR	21.12.2015

Tab. 1 Modifications Overview

Inhaltsverzeichnis

COPYRIGHTS AND PROPERTY RIGHTS	3
REVISION HISTORY	4
GENERAL	11
1 About this Manual	11
1.1 Applicable Documentation	11
1.2 Signs and Definitions used	12
1.3 Abbreviations used	12
2 Connections and Control Elements	12
2.1 Power Supply	12
2.2 NivuFlow Control Elements	13
2.3 Tasks of the control elements	13
2.4 Interfaces	14
SAFETY INSTRUCTIONS	15
3 General: Used Symbols and Signal Words	15
3.1 Information on the Valuation of Accident Levels	15
3.2 Warning Notices on the Device (optional)	16
4 Special safety and Precautionary Measures	16
5 Warranty	17
6 Disclaimer	17
7 Intended Use	18
8 Ex Protection	18
9 Duties of the Operator	19
10 Requirements for the Personnel	20
DELIVERY, STORAGE AND TRANSPORT	21
11 Scope of Delivery	21
12 Inspection upon Receipt	21
13 Storage	21
14 Transport	21
15 Return	22

PRODUCT SPECIFICATION	23
16 Product Construction and Overview	23
16.1 Construction	23
16.2 Enclosure Dimensions	24
16.3 Connectable Sensors.....	25
16.4 Device ID.....	25
17 Specifications	26
18 Equipment	28
18.1 Device Versions	28
18.2 Add-On Function Licences.....	29
FUNCTIONAL DESCRIPTION	30
19 Areas of Use	30
20 Functional Principles	31
20.1 Flow Velocity Measurement	31
20.2 Flow Rate Calculation	32
INSTALLATION AND CONNECTION	33
21 General Mounting Instructions	33
21.1 Avoiding electrostatic discharge (ESD).....	33
21.2 Installation/Mounting Variants	33
21.3 Selecting the Mounting Place.....	34
21.4 Fastening the transmitter to a DIN rail in the control cabinet	35
21.5 Fastening the field enclosure and preparations for electrical installation.....	35
22 Electrical Installation	37
22.1 Connection to the spring-cage terminal blocks	37
22.2 Terminal Wiring Diagrams	39
22.3 Connecting the Power Supply	45
22.3.1 DC Power Supply	45
22.3.2 Power Supply AC	46
22.4 Relay	47
23 Installation and Connection of Sensors	47
23.1 Sensor Installation Principles	47
23.2 Installation of Clamp-On Sensors	48
23.3 Installation of wetted Sensors	48
23.4 Path Arrangements	48
23.5 Cables and Cable Lengths for Sensor Connection	49
23.6 Connecting Sensors to NivuFlow	49
23.6.1 Sensor connection with 1-path measurement / 2-path measurement	50
23.7 Connection using NFE Extension Modules.....	52

24	Controller Mode (function can be added via licence)	53
24.1	General	53
24.2	Construction of a Control Section	54
24.3	Wiring diagram for controller mode	55
24.4	Control Algorithm	55
25	Overvoltage Protection Measures	56
25.1	Overvoltage protection for the power supply	58
25.2	Overvoltage Protection for mA Inputs/Outputs	59
25.3	Overvoltage Protection for Communication Interfaces	59
25.4	Overvoltage Protection for (Transit Time) Sensor Connections	60
25.4.1	Basic Protection - Potential Equalisation Cable	60
25.4.2	Extended Protection - Overvoltage Protection "SonicPro T"	60
COMMISSIONING		64
26	Notes to the User	64
27	Principles of Operation	65
27.1	Overview Display	65
27.2	Using the Control Elements	65
27.3	Input via Keypad	67
27.4	Input via Numeric field	68
27.5	Input Correction	68
27.6	Menus	68
28	Measuring with Clamp-On Sensors	69
29	Measuring with wetted Sensors	70
COMMISSIONING EXAMPLES		71
30	Parameterisation of a diametral 1-path Measurement	71
30.1	Simple Parameterisation Procedure	71
30.2	Extended Parameterisation Procedure	74
MAIN SCREEN		75
31	General Overview	75
31.1	Display Field Flow of Measurement Places 1 and 2	77
31.2	Display Field Level of Measurement Places 1 and 2	78
31.3	Display Field Velocity of Measurement Places 1 and 2	78
31.4	Display Field Temperature of Measurement Places 1 and 2	79
31.5	Display Field Total of Measurement Places 1 and 2	79
31.6	Display Field Trend/Hydrograph of Measurement Places 1 and 2	80
31.7	Display Field Flow of the Combi Measurement Place	80
31.8	Display Field for Measurement Place 1/2 in the Combi Measurement Place	81
31.9	Display Field Total of the Combi Measurement Place	82

SETTING PARAMETERS	83
32 Basics	83
32.1 Save Parameters	83
32.2 Change Password.....	83
33 Parameter Functions	84
33.1 Main Menu	84
33.2 Functions of the first Menu Level	85
33.2.1 Menu - Application / MP1 / MP2 / Combi.....	85
33.2.2 Menu - Data.....	86
33.2.3 Menu - System	87
33.2.4 Menu - Communication	88
33.2.5 Menu - Display.....	88
33.2.6 Menu - Connections	89
34 Parameter Menu Application / MP1 / MP2 / Combi	89
34.1 Setting the Parameters in the Measurement Place Menu	89
34.1.1 Active/Activation of Measurement Places (only with multiple Measurement Places)	90
34.1.2 Measurement Place Name	90
34.1.3 Transit Time Mode.....	91
34.1.4 Number of Paths	92
34.1.5 SonicPro T.....	92
34.1.6 Medium.....	92
34.1.7 (Medium) Temperature	92
34.1.8 Channel Profile.....	93
34.1.9 Wall material.....	93
34.1.10 Lining.....	94
34.1.11 Sludge Level.....	94
34.1.12 3D Preview	94
34.1.13 Low-flow suppression.....	94
34.1.14 Damping	95
34.1.15 Stability.....	95
34.2 Setting the Parameters in the Measurement Place Menu of the Combi Measurement Place	96
34.3 Setting Parameters in Menu v-Paths	97
34.3.1 Active.....	97
34.3.2 Cloning	97
34.3.3 Sensor Types in Transit Time Mode >Clamp-On<.....	98
34.3.4 Sensor Types in Transit Time Mode >Wetted<.....	98
34.3.5 Serial number	99
34.3.6 Installation/Mounting Position of Sensors	99
34.3.7 Mounting Support (only for NIS-V200R and NIS0V200RL).....	101
34.3.8 Weighting	102
34.3.9 v-Minimum and v-Maximum	103

34.3.10	v-Path Error	103
34.3.11	Offset (Difference)	103
34.4	Setting Parameters in the Inputs and Outputs Menu (analogue and digital) ...	104
34.4.1	Analogue Inputs	105
34.4.2	Analogue Outputs.....	105
34.4.3	Digital Inputs.....	107
34.4.4	Digital Outputs.....	108
34.5	Setting Parameters of the Flow Controller (Q-Controller) (function can be added via licence)	110
34.6	Setting Parameters in Menu Diagnostics	112
35	Parameter Menu Data.....	113
35.1	Trend.....	113
35.2	Total.....	115
35.3	Day Totals	115
35.4	USB Stick.....	117
35.5	Data Memory (Internal)	122
35.5.1	Basic Functions	122
35.5.2	Cycle Mode / Clock Control (function can be added via licence)	123
35.6	Operating Hours.....	129
36	Parameter Menu System.....	130
36.1	Information	130
36.2	Country Settings.....	131
36.2.1	(Operating) Language	131
36.2.2	Date Format.....	131
36.2.3	Units	131
36.2.4	Data Units.....	133
36.3	Time/Date.....	134
36.4	Error Messages	135
36.5	Service	135
36.5.1	Service Level.....	136
36.5.2	Change (System) Password.....	136
36.5.3	Feature Unlock	137
36.5.4	Restart.....	137
36.5.5	Restart Measurement.....	138
36.5.6	Parameter Reset	138
36.5.7	Disable Coin Cell (Backup Battery)	138
36.5.8	Update NivuFlow	139
37	Parameter Menu Communication	140
37.1	TCP/IP	140
37.2	Web Server	141
37.3	Data Transmission	143
37.4	Alarm.....	147
37.5	Modbus	148

38	Parameter Menu Display	149
39	Parameter Menu Connections	153
DIAGNOSTICS		154
40	Basics of the Diagnostics Menu	154
41	Diagnostics v-Paths	155
42	Diagnostics Inputs and Outputs (analogue and digital).....	156
42.1	Analogue Inputs	157
42.2	Analogue Outputs	157
42.3	Digital Inputs	158
42.4	Digital Outputs.....	159
43	Diagnostics Flow Controller (Q-Controller) (function can be added via licence)	160
44	Diagnostics Signal Analysis.....	162
45	Diagnostics Simulation.....	167
ERROR MESSAGES		169
46	Displayed Error Messages, Cause of Error and Troubleshooting	169
MAINTENANCE AND CLEANING		173
47	Maintenance.....	173
47.1	Maintenance Interval.....	173
47.2	Customer Service Information.....	173
48	Cleaning	174
48.1	Transmitter	174
48.2	Transducers	174
49	Dismantling/Disposal.....	174
50	Installation of Spare Parts and Accessories.....	175
51	Accessories	176
INDEX		178
OPEN SOURCE SOFTWARE		181
52	List of Sources of the Licences and Codes used.....	181
APPROVALS AND CERTIFICATES		182

General

1 About this Manual



Important Notice

READ CAREFULLY BEFORE USE!

KEEP IN A SAFE PLACE FOR LATER REFERENCE.

This instruction manual is for the transmitters NivuFlow 600 and NivuFlow 600 WS and serves their intended use. This instruction manual is oriented exclusively to qualified expert personnel. Read this instruction manual carefully and completely prior to installation or connection since it contains relevant information on this product. Observe the notes and particularly follow the warning notes and safety instructions.

If you should have problems to understand information contained within this instruction manual either contact a member company of the NIVUS group or one of the distributors for further support. The member companies of the NIVUS group cannot be held responsible for damage to persons or material due to incorrectly understood information in this instruction.



Note

For the sake of simplicity, only the NivuFlow 600 is usually mentioned in these operating instructions; the data, drawings and explanations are also always valid for the flow transmitter NivuFlow 600 WS. Provided that it has the equipment and functionalities mentioned.

Depending on the equipment/transmitter type, the descriptions and display illustrations may differ from those shown in the instruction manual.

Special equipment in the form of several measuring points is possible with the NivuFlow 600 Type T4/G4/TM/GM transmitters; a controller function can be optionally available with the NivuFlow 600 type TR/GR/TZ/GZ transmitters. The illustrations and descriptions for this equipment are not valid for the other transmitter types.





1.1 Applicable Documentation

For the installation and operation of the complete system extra instruction manuals or technical descriptions may be required apart from this instruction manual.

- Technical Description Transit Time Sensors
- Mounting Instruction Transit Time Sensors
- Technical Description NIVUS MODBUS TCP/RTU Application Interface for series NivuFlow 5xx, 6xx, 7xx, Energy Saver and NivuParQ 850 Transmitters
- Technical Instructions Extension Module NFE
- Technical Description Ex Separator Module pXT0 - Transit Time
- Technical Description for Pressure and Level probes: NivuBar Plus II, NivuBar G II and HydroBar G II
- Technical Description for Pressure and Level probes: NivuBar H
- Technical Description for Pressure and Level probes: AquaBar BS, AquaBar II and UniBar E II

These manuals are provided with the auxiliary units or sensors and/or are available as download on the NIVUS homepage.

1.2 Signs and Definitions used

Representation	Meaning	Remarks
	(Action) Step	Execute action steps. Should action steps be numbered observe the specified order of the steps.
	Cross-reference	Refers to further or more detailed information.
	Documentation Reference	Refers to an accompanying documentation.
>Text<	Parameter or menu	Indicates a parameter or a menu that is to be selected or is described.
	Graphic/Table Info	Additional information in the legend of a chart or table.

Tab. 2 Structural elements within the manual

1.3 Abbreviations used

Colour code for wires, single conductors and components

The abbreviations of colours for wire and single conductor labelling follow the international colour code according IEC 60757.

BK	Black	BN	Brown	RD	Red
OG	Orange	YE	Yellow	GN	Green
BU	Blue	VT	Violet	GY	Grey
WH	White	PK	Pink	TQ	Turquoise
GNYE	Green/Yellow	GD	Gold	SR	Silver

2 Connections and Control Elements

2.1 Power Supply

The connection for the power supply of the transmitter is located in the lower area of the terminal strip X1.

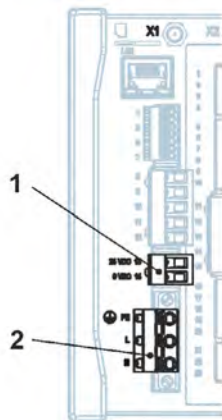

- 1 DC/DL Power Supply
- 2 AC Power Supply and Protective Earth Connection

Fig. 2-1 Power supply terminal clamps

 A detailed wiring diagram can be found in Chap. "22.2 Terminal Wiring Diagrams".

2.2 NivuFlow Control Elements

The entire parameterisation is menu-driven. The graphics of the display support you with this. The rotary pushbutton and the two function keys are used to select the individual menus and submenus.

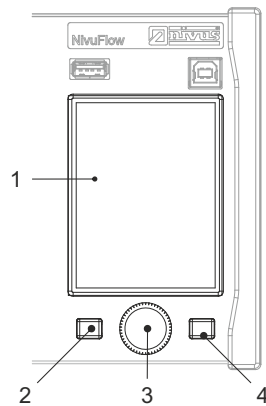

- 1 Colour Display
- 2 Left Function Key
- 3 Rotary Pushbutton
- 4 Right Function Key

Fig. 2-2 Control Elements

2.3 Tasks of the control elements

Colour Display

You can read off all settings during parameterisation and diagnostics.

Left Function Key (Menu or Back)

Press this key (Menu) to go from the main display to the main menu. The same key (Back) is also needed to exit the main menu and the submenus.

Rotary Pushbutton

Use the rotary pushbutton to access the individual submenus. The functions are also controlled via the rotary pushbutton.

- Selection of the desired parameter or menu
- Navigation through the submenus and settings
- Selection of letters or numbers for parameterisation

Right Function Key (Enter or Tab)

Use this key to confirm the entry of values (via numeric keypad or alphabetic keypad).

For some parameters, the right function key serves as a >Tab<. This Tab function is always present when digits are visible at the top right of the display. Then the Tab function is used to switch between pages/displays. This applies for the settings below:

- Menu >Application<
 - Selection of v-Paths
 - Selection of Analogue Inputs / Analogue Outputs
 - Selection of Digital Inputs / Digital Outputs
 - Diagnostics of v-Paths
 - Diagnostics Signal Analysis

- Menu >Data<
 - Selection of trend, total and daily totals for measurement place 1/2 and combined measurement place (with multiple measurement places)
- Main Screen
 - Selection of screen for measurement place 1/2 and combi measurement place (with multiple measurement places)

⇒ A description of how to use the control elements can be found in Chap. “27 Principles of Operation”.

2.4 Interfaces

The transmitter has multiple interfaces on the front of the device.

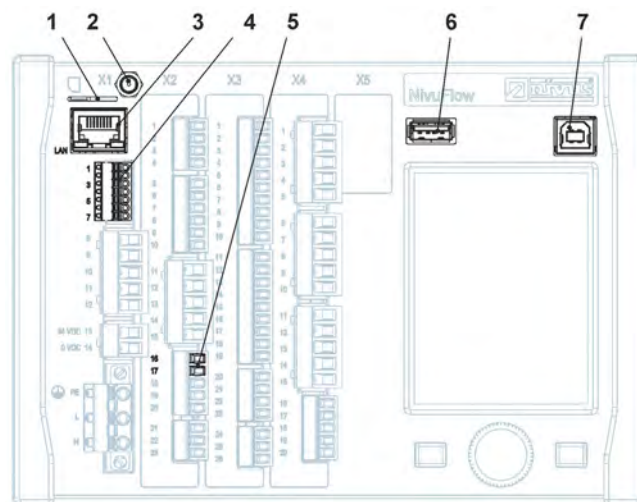

- 1 Slot for SIM card (alternative data transmission via internal 2G/3G/4G modem, only with Type G2/GR/G4/GM/GZ/GD)
- 2 Antenna socket (for internal 2G/3G/4G modem; only with Type G2/GR/G4/GM/GZ/GD)
- 3 Network Interface (LAN)
- 4 BUS Interface (RS485/RS232)
- 5 Analogue Input
- 6 USB-A Interface (data transfer, parameter backup, device update)
- 7 USB-B Interface (service mode)

Fig. 2-3 Available interfaces

⇒ A description of the individual interfaces can be found in Chap. “37 Parameter Menu Communication”.

Safety Instructions

3 General: Used Symbols and Signal Words

3.1 Information on the Valuation of Accident Levels



The general warning symbol indicates the risk of personal injuries or death. In the text section the general warning symbol is used in combination with the signal words described below.

DANGER

Warning in high degree of risk



Indicates a high-risk, **imminently** hazardous situation which will result in death or serious injury if not avoided.

WARNING

Warning in medium degree of risk and personal injury



Indicates a **possible** danger with medium risk which may result in a life-threatening situation or (severe) bodily injury if not avoided.

CAUTION

Warning in personal injury or property damage



Indicates a possible danger with moderate risk which may result in minor or moderate personal injury or property damage if not avoided.

WARNING

Danger by electric voltage



Indicates a medium-risk, **imminently** hazardous situation caused by electric shock which will result in death or (serious) injury if not avoided.



Important Notice

Contains information that needs to be highlighted.

Indicates a potentially harmful situation that may damage the product or something in its environment if not avoided.



Note

Contains tips or information.

3.2 Warning Notices on the Device (optional)



General Warning Notice

This symbol refers the operator or user to content in this instruction manual.

Consideration of the information contained herein is necessary to maintain the protection provided by the unit for installation and in operation.



Protective earth connection

This symbol refers to the protective conductor terminal of the device.

Depending on the type of installation, the unit may only be operated with a suitable protective earth connection in accordance with applicable laws and regulations.

4 Special safety and Precautionary Measures

When working with the NIVUS equipment, the following safety and precautionary measures must be observed and followed generally and at all times. These warnings and notes are not repeated for each description within the document.

WARNING



Check danger due to explosive gases

Before starting assembly, installation and maintenance work, be sure to check that all regulations on safety at work have been observed and that there is no possible risk of explosive gases. Use a gas warner for the check.

When working in the sewer system, make sure that no electrostatic charge can occur:

- *Avoid unnecessary movements to reduce the building-up of static charges.*
- *Discharge any static electricity present on your body before you start installing sensors.*

Disregarding may result in personal injury or damage to the system.

WARNING



Germ Contamination

Particularly due to the use of the sensors in the waste water sector, parts can be contaminated with dangerous germs. Therefore, appropriate precautions must be taken when coming into contact with cables and sensors.

Wear protective clothing.

WARNING



Observe Occupational Safety Regulations!

Before and during mounting works, compliance with all work safety regulations must always be ensured.

Disregarding may lead to personal injury.

WARNING



Do not disable Safety Devices!

It is strictly forbidden to disable the safety devices or to change their mode of operation.

Disregarding may result in personal injury or damage to the system.

WARNING



Disconnect the System from Mains Power

Disconnect the system from the mains power before starting maintenance, cleaning and/or repair work (only by qualified personnel).

Disregarding may lead to electric shock.



Commissioning only by qualified Personnel

The entire measuring system may only be installed and commissioned by qualified personnel.

Built-In Backup Battery

The backup battery integrated in the measurement device may only be replaced by NIVUS or personnel authorised by NIVUS. Non-compliance will result in a limitation of the warranty (see Chap. "5 Warranty").

5 Warranty

The device was functionally tested prior to shipping. When used for the intended purpose (see Chap. "7 Intended Use") and in compliance with the instruction manual, the applicable (see Chap. "1.1 Applicable Documentation") and the safety information and instructions contained therein, no functional restrictions are to be expected and flawless operation should be possible.



Please also refer to the following chapter "6 Disclaimer".



Limitation of Warranty

In case of disregarding the safety notes and instructions in this document, the companies of the NIVUS-Group reserve the right to limit the warranty.

6 Disclaimer

The companies of the NIVUS-Group assume no liability

- for consequential damages resulting from a **change** in this document. The companies of the NIVUS-Group reserve the right to change the contents of this document including this disclaimer without prior notice.
- for personal injury or damage to property resulting from **failure to comply** with the applicable **regulations**. For connection, commissioning and operation of the devices/sensors, all information and higher-level legal regulations of the country (in Germany e.g. the VDE regulations), such as valid Ex regulations as well as the safety and accident prevention regulations applicable to the respective individual case shall be observed.
- for personal injury or damage to property resulting from **improper handling**. For safety and warranty reasons, all work on the equipment that goes beyond the installation and connection measures may only be carried out by NIVUS personnel or by persons or companies authorised by NIVUS.
- for personal injury or damage to property resulting from the operation of the equipment in a technically **faulty** condition.
- for personal injury or damage to property resulting from **improper use**.
- for personal injury or damage to property resulting from **failure to observe the safety instructions** in this instruction manual.
- for missing or incorrect readings due to **improper installation or faulty parameterisation/programming** and for any consequential damage resulting therefrom.

7 Intended Use



Note

The device is intended exclusively for the purpose mentioned below. Any other use beyond this, any conversion or modification of the instrument without written agreement with the companies of the NIVUS-Group is considered improper use.

The companies of the NIVUS-Group are not liable for any damage resulting from this. The operator alone bears the risk.

The **NivuFlow 600** transmitter, including the associated sensors, is designed for continuous flow measurement of liquids such as drinking water, waste water or return sludge in **full** pipes (round and rectangular).

The **NivuFlow 600 WS** transmitter was specially developed for drinking water applications.



See also Chap. "20 Functional Principles".

The transmitter is designed and produced according to the current state of the art and the recognised safety rules at the time of publication of this document. Nevertheless, risks of personal injury or damage to property cannot be completely ruled out.

The permissible maximum limit values in Chapter "17 Specifications" must be observed. All cases of use deviating from these limit values, which have not been approved by NIVUS GmbH in writing, are excluded from the liability of the NIVUS-Group.

8 Ex Protection

The NivuFlow 600 transmitter can be used in conjunction with a type pXT0 Ex Separation Module and the Ex-approved NIS, NIS0, NIC-CO sensors as well as the Ex-approved UniBar E II and HydroBar G II probes for use in areas with a Zone 1 explosive atmosphere. Here, the sensors/probes are installed directly in Ex zone 1, while the **transmitter** and the **Ex Separation Module** must be installed in **non-Ex areas**.

The connection diagrams can be found in the corresponding technical description / instruction manual for the sensors / probes or the pXT0 Ex Separation Module.

Sensors and Probes / Ex Separation Module Approvals



See "Technical Description Transit Time Sensors" or "Technical Description for Pressure and Level Probes: AquaBar BS, AquaBar II and UniBar E II" or "Technical Description for Pressure and Level Probes: NivuBar Plus II, NivuBar G II and HydroBar G II" or "Technical Description Ex Separator Module pXT0 - Transit Time".



Validity of the Ex Approval

The Ex approval is only valid in conjunction with the corresponding marking on the nameplate of the pXT0 Ex Separation Module and the sensors.



Declarations of Conformity and Test Certificates

For the installation and commissioning of sensors in potentially explosive atmospheres, the certificates of conformity and test certificates of the notified bodies as well as the applicable national regulations must be strictly observed.

The combination of the NivuFlow transmitter with the Ex Separation Module pXT0 is exclusively matched to the NIVUS transit time sensors NIS-, NIS0 and NIC-CO and the pressure and level probes UniBar E II and HydroBar G II with regard to the intrinsically safe system evaluation according to EN 60079-25.

When using sensors from other manufacturers, the operator must carry out a system assessment in accordance with EN 60079-25!

The technical data required for this for the Ex Separation Module pXT0 are specified in the associated EU type examination certificate.

9 Duties of the Operator



Strictly observe and comply with guidelines and requirements

In the EEA (European Economic Area), the national transposition of the Framework Directive (89/391/EEC) as well as the associated individual directives and, in particular, the Directive (2009/104/EC) concerning the minimum safety and health requirements for the use of work equipment by workers at work, as amended, must be observed and complied with. In Germany, the Ordinance on Industrial Safety and Health must be complied with.

Obtain the local operating licence and observe the associated conditions. In addition, you must comply with environmental protection requirements and local legal requirements for the following:

- Safety of personnel (Accident Prevention Regulations)
- Safety of work equipment (Protective Equipment and Maintenance)
- Product Disposal (Waste Management Act)
- Materials Disposal (Waste Management Act)
- Cleaning (Cleaning Agents and Disposal)

Connections

As the operator, before activating the device, make sure that the local regulations (e.g. for the electrical connection) have been observed during installation and commissioning.

Keep the Instruction Manual for future Reference

Keep the instruction manual in a safe place and ensure that it is always available and can be consulted by the user of the product.

Hand over the Instruction Manual

When selling the measurement device, this instruction manual must be handed over with it. The manual is part of the standard delivery.

10 Requirements for the Personnel

Installation, commissioning and maintenance may only be carried out by personnel who fulfil the following conditions:

- Qualified personnel with appropriate training
- Authorisation by plant operator



Qualified Personnel

in the sense of these instructions or the warnings on the product itself are persons who are familiar with the installation, assembly, commissioning and operation of the product and who have the qualifications appropriate to their job, such as

- I. training and instruction or authorisation to switch circuits and devices/systems on and off, to earth and to label them in accordance with the standards of safety technology,*
 - II. training or instruction in accordance with safety technology standards in maintenance and use of appropriate safety equipment,*
 - III. First Aid Training*
-

Delivery, Storage and Transport

11 Scope of Delivery

The standard delivery of the NivuFlow 600 / NivuFlow 600 WS usually comprises:

- Transmitter NivuFlow 600 / NivuFlow 600 WS (Type according to delivery documents)
- 2G/3G/4G antenna: Enclosed as a magnetic base antenna in the case of transmitters for mounting on DIN rails or attached as an adhesive antenna inside the transmitter in the case of transmitters mounted in NIVUS field enclosures (only with corresponding order: transmitter with modem).
- Connection cable with potential bridges (Fig. 23-8) for connection to the NFE extension module (only with corresponding order, Type TM/GM/TZ/GZ; incl. NFE preparation).
- Instruction manual with Declaration(s) of Conformity (printed copy or as link to the NIVUS download centre); It includes all information required for the operation of the NivuFlow 600 / NivuFlow 600 WS.

Check other accessories according to the order and on the basis of the delivery note.

12 Inspection upon Receipt

Check the delivery for completeness and apparent intactness immediately after receipt. Report any transport damage immediately to the delivering carrier. Also send a written report to NIVUS GmbH in Eppingen.

Incomplete deliveries must be addressed in writing within two weeks to your responsible representative or directly to the NIVUS GmbH in Eppingen.



Important Notice

Complaints received later will not be recognised.

13 Storage

Observe the minimum and maximum values for external conditions such as temperature and humidity according to Chap. "17 Specifications".

Protect the instrument from corrosive or organic solvent vapours, radioactive radiation and strong electromagnetic radiation.

Store the device in the original packaging.

14 Transport

Protect the device from strong impacts, shocks, jolts or vibrations.

Transport the device in the original packaging.

Otherwise, the same rules apply with regard to external influences as for storage (see Chap. "13 Storage").

15 Return

In the event of a return, send the unit to NIVUS GmbH in Eppingen carriage paid and in the original packaging.

Items that have not been sufficiently franked will not be accepted!

In general, a return note (incl. RMA return number) must be requested from the NIVUS customer service before returning the goods. Without this RMA number, the incoming goods cannot be assigned accordingly.



See Chap. "47.2 Customer Service Information".

Product Specification

16 Product Construction and Overview

16.1 Construction

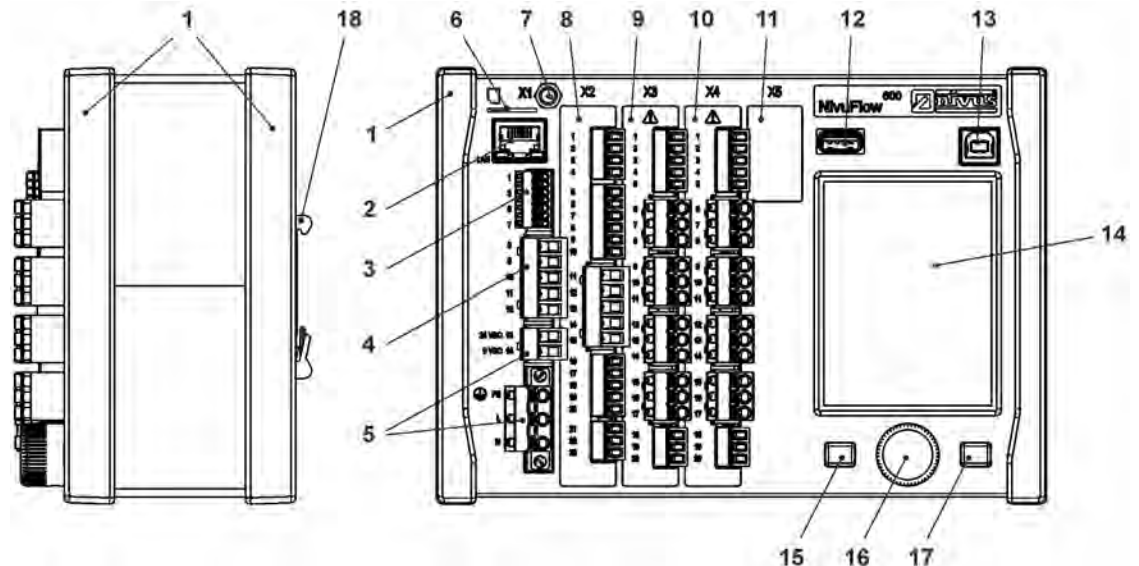

- 1 Cover Strips (only for control cabinet installation; installation variant E0)
- 2 Network Interface (LAN)
- 3 Bus Interface (RS485/RS232)
- 4 Placeholder for connection air-ultrasonic sensor (RS485) (NOT for NF 600 / NF 600 WS; only for identical devices)
- 5 Power Supply
- 6 Slot for SIM card (alternative data transmission via internal 2G/3G/4G modem, only with Type G2/GR/G4/GM/GZ/GD)
- 7 Antenna socket (for internal 2G/3G/4G modem; only with Type G2/GR/G4/GM/GZ/GD) (SMA, female)
- 8 Slot X2 (see Chap. "22.2 Terminal Wiring Diagrams")
- 9 Slot X3 (see Chap. "22.2 Terminal Wiring Diagrams")
- 10 Slot X4 (see Chap. "22.2 Terminal Wiring Diagrams")
- 11 Slot X5 - expansion slot (not used)
- 12 USB-A Interface (data transfer, parameter backup, device update)
- 13 USB-B Interface (service mode)
- 14 Graphic Display
- 15 Function Key, left
- 16 Rotary Pushbutton
- 17 Function Key, right
- 18 DIN rail fastening (for installation in NIVUS field enclosures; installation variant E1: fastened raised by 6 mm)

Fig. 16-1 Device construction NivuFlow 600 / NivuFlow 600 WS; installation variants E0/E1

16.2 Enclosure Dimensions

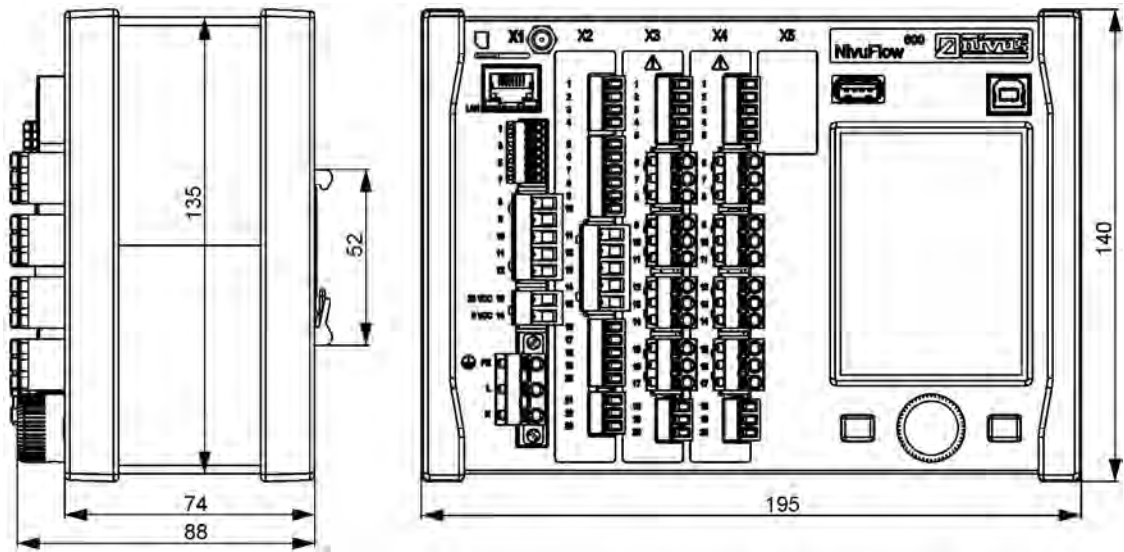
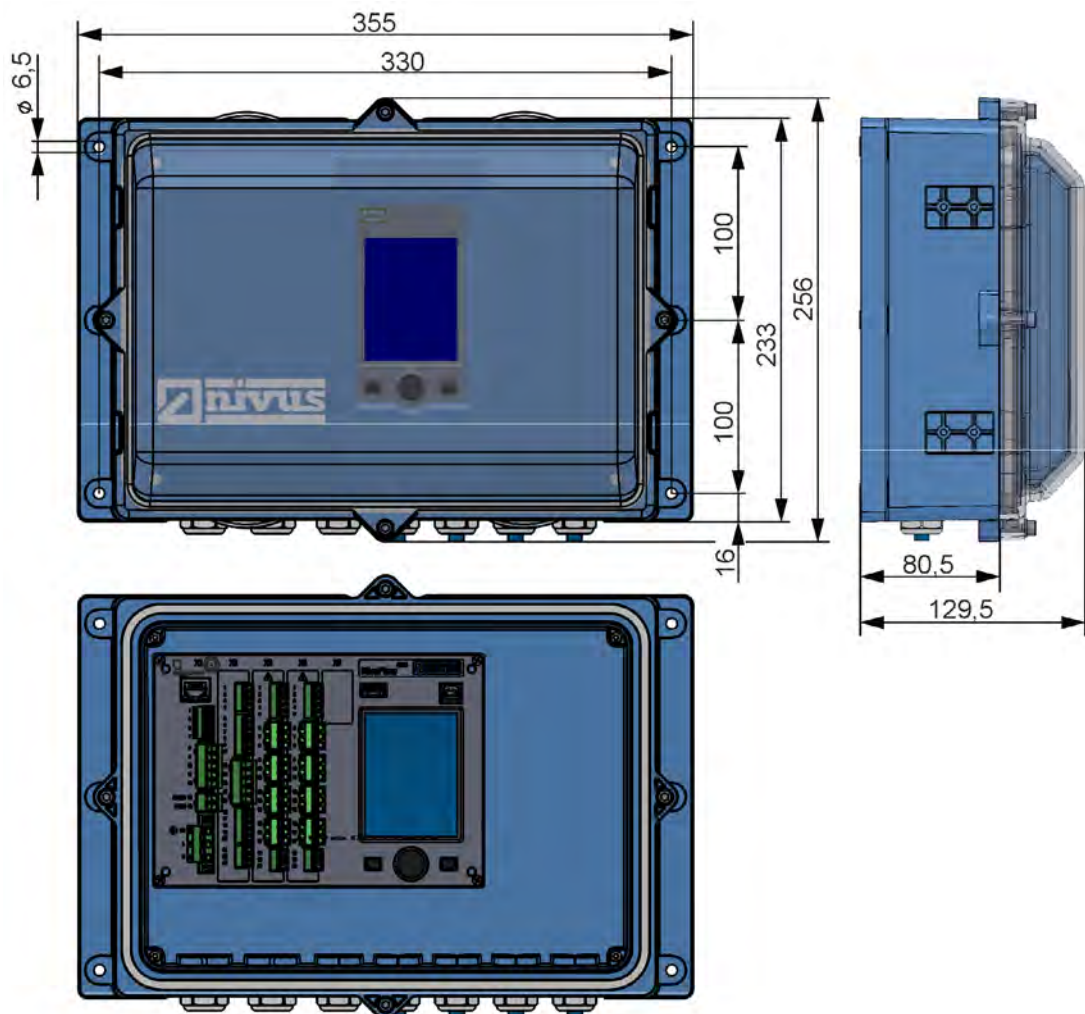

Fig. 16-2 Dimensions NivuFlow 600 / NivuFlow 600 WS; installation variant E0



Info: Bottom view without cover (NivuFlow visible, without pXT)

Fig. 16-3 Dimensions NivuFlow field enclosure; installation variant E1

16.3 Connectable Sensors



The connectable NIVUS sensors and their specifications or information on their installation can be found in the documents "Technical Description Transit Time Sensors" and "Installation Instructions Transit Time Sensors". These are supplied with the sensors ordered. Alternatively, they are available for download at www.nivus.com.



ALWAYS use the sensors in pairs

To measure a path according to the principle of transit time measurement, two matched (transit time) sensors are always required. The use of sensor pairs is therefore a basic requirement.

See also Chap. "20.1 Flow Velocity Measurement".

16.4 Device ID

The information in this instruction manual only apply to the devices indicated on the title page. The nameplate is attached to the side of the enclosure and contains the following information:

- Name and address NIVUS GmbH
- CE Label
- Marking of the series and type with article number and serial number
- Year of manufacture: the first four digits of the serial number refer to the year of manufacture and the week number (2325.....)
- Power supply (see Article No. and Chap. "18.1 Device Versions")

It is important for all queries and spare parts orders that the article number and serial number of the respective device are specified correctly. This is the only way to ensure proper and fast processing.



Note

Check by means of the nameplates whether the supplied device corresponds with your order.

Check that the correct voltage supply is indicated on the nameplate (bottom left field).



The EU Declarations of Conformity can be found at the end of this instruction manual.

Nameplates (Examples)

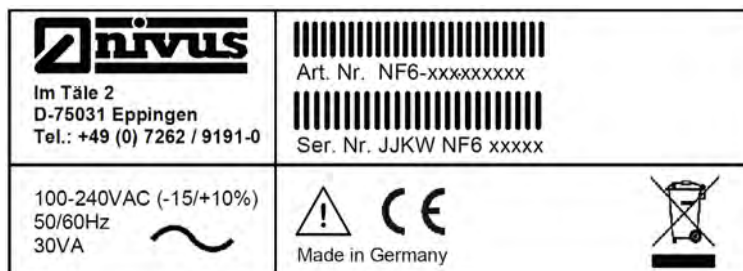

Fig. 16-4 Nameplate AC version

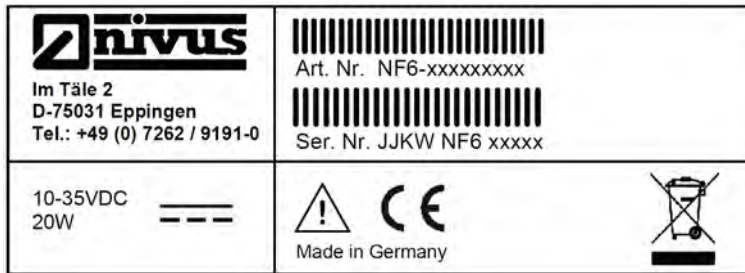

Fig. 16-5 Nameplate DC version

17 Specifications

Power Supply	100...240 V AC, -15 % / +10 %, 47...63 Hz or 10...35 V DC
Connection Power Supply	AC: Plugged and screwed on spring-cage terminal block DC/DL: Plugged spring-cage terminal block
Maximum Power Consumption	AC: 30 VA / DC: 20 W
Typical Power Consumption	1x Relay energised, up to four transit time difference paths 1 MHz 230 V AC: 14 VA / 6.8 W 24 V DC: 6.2 W
Enclosure	DIN Rail Material: Aluminium and Plastic Weight: approx. 1,300 g Field Enclosure Material: Polyamide (PA), Polycarbonate (PC) Weight: approx. 3,900 g (incl. NF600) Dimensions see Chap. 16.2.
Protection Class (IEC 60529) / Shock Resistance (IEC 62262)	DIN Rail IP20 / IK08 Field Enclosure IP67 (optional: IP68) / IK08
Operating Conditions	Protection Class I Overvoltage Category II Pollution Degree 2
Application Altitude	AC unit for use at altitudes up to 3000 m above MSL. For relay voltages >150 V, use is restricted to altitudes up to max. 2000 m above MSL (AC and DC units)
Operation Temperature	DC: -20...+70 °C AC: -20...+65 °C
Storage Temperature	-30...+80 °C
Max. Ambient Temp. for Installation and Operation	+50 °C
Max. Humidity	80 %, non-condensing
User Indicator	Daylight-readable TFT colour graphic display, 240x320 pixel, 65,536 colours

Setting Parameters/Programming	Menu-driven using rotary pushbutton and two function keys, in English, German, French, Italian, Spanish, Portuguese, Swedish, Danish, Finnish, Polish, Hungarian, Romanian, Czech, Russian, Korean and Chinese language
Connection	<ul style="list-style-type: none"> - General: Plugged spring-cage terminal block - AC Power Supply: Plugged and screwed on spring-cage terminal block
Inputs	<p>Digital Input:</p> <ul style="list-style-type: none"> - galvanically isolated 5...24 V nominal, input current typ. less than 5 mA at max. input voltage $U_{in}=30\text{ V}$, input current typ. greater than 1.5 mA at min. input voltage $U_{in}=3\text{ V}$ <p>Analogue Input:</p> <ul style="list-style-type: none"> - 4 mA...20 mA with 12-bit resolution for analogue input values, accuracy $\pm 0.4\%$ of the measured value range (20 mA), load 91 Ohm
Outputs	<p>Digital Output:</p> <ul style="list-style-type: none"> - Relay (SPDT), loadable up to 230 V AC / 2 A (cos 0.9 phi), recommended minimum switching current 10 mA @ 5 V - bistable relay (SPDT), loadable up to 230 V AC / 2 A (cos 0.9 phi), recommended minimum switching current 10 mA @ 12 V <p>Analogue Output:</p> <ul style="list-style-type: none"> - 0/4 mA...20 mA, load 500 Ohm, 12 bit resolution, accuracy better than $\pm 0.1\%$ at 20 °C
Flow Controller	1x 3-step controller, quick close control, adjustable slide valve position in the event of a fault (flow controller only available for Types TR/GR/TZ/GZ)
Data Memory	Internal 1.0 GB, for parameterisation/programming and measurement backup for approx. 570,000 data sets (time stamps); can be read via front-side USB stick
Storage Cycle	Starting at 30 seconds (depending on operation mode)
Communication	<ul style="list-style-type: none"> - Modbus TCP via networks (LAN/WAN, Internet) - Modbus RTU via RS485 or RS232 - SMTP/FTP/HTTP - 2G/3G/4G via built-in radio communications modem (only with Type G2/GR/G4/GM/GZ/GD)

Tab. 3 Specifications NivuFlow 600 / NivuFlow 600 WS



The specifications of the associated sensors can be found in the corresponding instructions or technical descriptions.

18 Equipment

18.1 Device Versions

The NivuFlow 600 / NivuFlow 600 WS is manufactured in different versions. The article number results from the combination of the individual product structure elements. This is written also on the nameplate (see "Nameplates (Examples)" on page 25).

NF6-	Flow Measurement Transmitter for Measurement in full Pipes. Supply, Parameterisation, Calculation and Display of the connected Flow Velocity and Level Sensors. Flow Velocity Signal Evaluation using Transit Time Difference method via multi-path measurements with up to 32 paths (64 sensors); analogue and digital Outputs; Communication: TCP/IP via Intranet or Modbus TCP/RTU					
	Design					
	0	For permanent full pipelines; function extension through software licences				
	Type					
	T2	Up to 2 acoustic paths, 2x DI, 2x DO, 2x AI, 2x AO				
	G2	Up to 2 acoustic paths, 2x DI, 2x DO, 2x AI, 2x AO, with internal modem; modem card Global; IoT-ready				
	TR	Up to 2 acoustic paths, 7x DI, 5x DO, 5x AI, 4x AO				
	GR	Up to 2 acoustic paths, 7x DI, 5x DO, 5x AI, 4x AO; with internal modem; modem card Global; IoT-ready				
	T4	Up to 4 acoustic paths, 2x DI, 2x DO, 2x AI, 2x AO				
	G4	Up to 4 acoustic paths, 2x DI, 2x DO, 2x AI, 2x AO, with internal modem; modem card Global; IoT-ready				
	TM	Measurement Transmitter for connection of NFE Extension Modules (up to 32 paths), 2x DI, 2x DO, 2x AI, 2x AO				
	GM	Measurement Transmitter for connection of NFE Extension Modules (up to 32 paths), 2x DI, 2x DO, 2x AI, 2x AO; with internal modem; modem card Global; IoT-ready				
	TZ	Measurement Transmitter for connection of NFE Extension Modules (up to 32 paths), 7x DI, 5x DO, 5x AI, 4x AO				
	GZ	Measurement Transmitter for connection of NFE Extension Modules (up to 32 paths), 7x DI, 5x DO, 5x AI, 4x AO; with internal modem; modem card Global; IoT-ready				
	Construction					
E0	DIN rail/control cabinet mounting, IP20					
E1	DIN rail, prepared for mounting into NIVUS field enclosure					
Power Supply						
A0	100 - 240 V AC					
D0	10 - 35 V DC					
DL	Clocked cycle and event-based operation, 10 - 35 V DC					
Firmware Extension						
0	None					
Number of measurement places						
1	One measurement place					
0	Two measurement places (only Type T4/G4/TM/GM)					
NF6-	0				0	

Tab. 4 Product Structure NivuFlow 600

NF6-	Flow Measurement Transmitter for Drinking Water Applications.					
	For measurement in full pipes.					
	Supply, Parameterisation, Calculation and Display of the connected Flow Velocity Sensors. Flow Velocity Signal Evaluation using Transit Time Difference method via single-path measurement (2 sensors); analogue and digital Outputs; Communication: TCP/IP via Intranet or Modbus TCP/RTU;					
	Use only in combination with NIC-CO01 sensors.					
	Design					
	D	For permanent full pipelines; Application: drinking water				
		Type				
		TD	1 acoustic path, 1x DI, 1x DO, 1x AI, 1x AO			
		GD	1 acoustic path, 1x DI, 1x DO, 1x AI, 1x AO, with internal modem; modem card Global; IoT-ready			
		Construction				
	E0	DIN rail/control cabinet mounting, IP20				
	E1	DIN rail, prepared for mounting into NIVUS field enclosure				
	Power Supply					
	A0	100 - 240 V AC				
	D0	10 - 35 V DC				
	Firmware Extension					
	0	None				
	Number of measurement places					
	1	One measurement place				
NF6-	D				0	1

Tab. 5 Product Structure NivuFlow 600 WS



Observe country-specific differences

The transmitter types listed in the tables Tab. 4 / Tab. 5 are not all available in every country. For details, please contact the companies in the NIVUS group or your local representative.

18.2 Add-On Function Licences

The NivuFlow 600 transmitter can be equipped with supplementary functions at extra charge (not the NivuFlow 600 WS). The following function extensions are currently available as (software) licences:

- Remote data transmission via FTP and E-Mail (required if a customer SIM card is used)
- Clocked operation (cycle mode/clocked control) of permanent NivuFlow 600 transmitters (not NivuFlow 600 WS)
- Q-Controller functionality (flow controller) for Types TR/GR/TZ/GZ
- Radio Transmission of Data Depth >Extended< (data depth >Standard< works without licence)
- Radio Transmission of Data Depth >Expert< (data depth >Standard< works without licence)



The functions are activated according to Chap. "36.5.3 Feature Unlock":

Functional Description

19 Areas of Use

The **NivuFlow 600** is a permanent measurement system for flow measurement in liquids such as drinking water, waste water and return sludge.

The NivuFlow 600 is used in full filled pipes of various shapes and dimensions.

The NivuFlow 600 can operate up to two measurement places individually or as a combined measurement place. This can be used to take a measurement at two points within the same pipe or to take a measurement in two different pipes.

The **NivuFlow 600 WS** is a permanent measurement system for flow measurement especially for drinking water applications.

The NivuFlow 600 WS is used in full filled pipes of various shapes and dimensions. Clamp-on sensors can be used to measure pipes from DN50...DN800 in one measurement path.



The connectable NIVUS sensors and their specifications or information on their installation can be found in the documents "Technical Description Transit Time Sensors" and "Installation Instructions Transit Time Sensors". These are supplied with the sensors ordered. Alternatively, they are available for download at www.nivus.com.

The use of several pairs of sensors can help to record the flow velocity more accurately or may be necessary from a hydraulic point of view to record the measurement place.



Note on the Measurement Range

The measurement method for determining the flow velocity is based on the principle of the transit time difference. For this system to function, it is essential that there are as few particles and disturbing particles as possible in the medium (dirt particles, gas bubbles or similar). These particles scatter or attenuate the ultrasonic signal and may prevent a measurement.

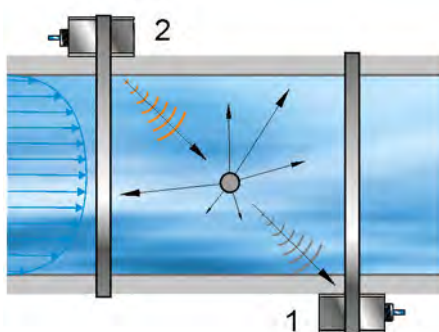
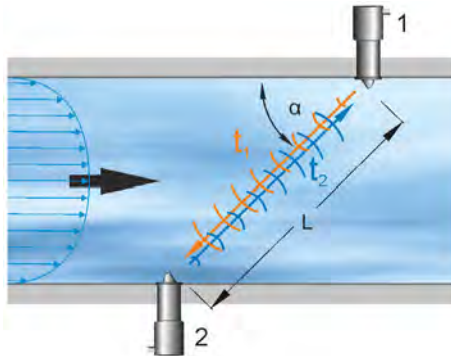

Fig. 19-1 Signal attenuation due to disturbing particles (example with clamp-on sensors)

20 Functional Principles

20.1 Flow Velocity Measurement

The flow velocity is determined using the ultrasonic transit time difference principle.



- 1 Sensor 1
- 2 Sensor 2
- α Defined angle
- t_1 Time of impulse **against** the flow direction
- t_2 Time of impulse **with** the flow direction
- L Path length

Fig. 20-1 Transit time measurement principle with one path

This measurement principle is based on the direct measurement of the transit time of an acoustic signal between two ultrasonic sensors. These sensors are also called hydroacoustic transducers.

The transit time difference method does not determine the average path velocity, but the effective velocity of sound propagation upstream (slowed down by the flow) and downstream (accelerated by the flow).

Two sound pulses are sent one after the other and the different transit times between transmitter and receiver are measured.

- The impulse upstream takes a time t_1 .
- The impulse downstream takes a shorter time t_2 .

The downstream sound reaches the receiver in a shorter time than the upstream sound. The difference between these transit times is proportional to the average path velocity (flow velocity in the measurement path).

If both sensors receive the transmitted ultrasonic impulses at the same time, then there is no difference in transit time. No flow is present.

The NivuFlow 600 works with both contactless clamp-on sensors and wetted sensors. The clamp-on sensors are attached to the outside of the pipe. Here, the penetration of the pipe material is also calculated and taken into account.

In order to be able to determine the flow rate, the cross-section and flow geometry of the pipe, canal or water body must be known.

This formula is used for this purpose:

$$v = \frac{L}{2} \cdot \left[\frac{1}{t_2} - \frac{1}{t_1} \right]$$

with:

- L = Length of the acoustic measurement path between sensors 1 and 2
- v = Average value of the path velocity between sensors 1 and 2 along the measurement path

The more paths are used for the transit time measurement in the asymmetrical or disturbed profile and distributed in the cross-section flowed through, the more accurate the flow can be determined.

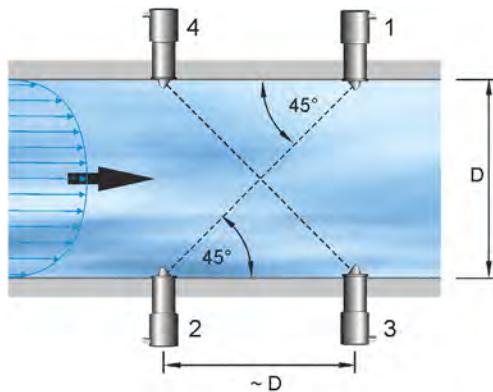

- 1 Sensor 1, Path 1
- 2 Sensor 2, Path 1
- 3 Sensor 1, Path 2
- 4 Sensor 2, Path 2
- D Pipe diameter (for sensor installation at 45° angle)

Fig. 20-2 Transit time measurement principle with two paths

When installing the sensors at a 45° angle, the distance between sensor 1 and sensor 2 or sensor 3 and sensor 4 corresponds approximately to the inner pipe diameter.

20.2 Flow Rate Calculation

When using single or multi-path systems in a flat plane under the condition

$$Q = v_{\text{average}} \cdot A$$

with

- v_{average} = average path velocity
- A = Area of the flow cross section

a velocity coefficient "k" must be included to compensate for the difference between the measured velocity v_g and the mean velocity v_{average} in the cross-section.

The velocity coefficient "k" depends on the Reynolds number and is therefore not a constant. Reynolds number and velocity coefficient are not visible or changeable, they are integrated in the software and are included in the background calculations.

According to this, the flow can be calculated with the transit time of the signal as follows:

$$Q = k \cdot A \cdot v_g = k \cdot A \cdot \frac{L}{2 \cdot \cos \alpha} \cdot \left[\frac{1}{t_2} - \frac{1}{t_1} \right]$$

Installation and Connection

21 General Mounting Instructions

During installation, observe the following instructions on "Electrostatic Discharge (ESD)" and "Installation Location".

- ➡ It is essential to follow applicable legal or company guidelines.

Improper handling may lead to personal injuries and/or equipment damage!

21.1 Avoiding electrostatic discharge (ESD)



ESD Risks

Maintenance procedures that do not require power to the unit must only be carried out after disconnection from the mains to minimise hazards and ESD risks.

Disconnect the NivuFlow from the mains.

The sensitive electronic components inside the unit can be damaged by static electricity. NIVUS GmbH recommend the following steps to prevent damage to the device due to electrostatic discharge:

- ➡ Before touching electronic components of the appliance, discharge any static electricity from the body.
- ➡ Avoid unnecessary movements to minimise the building-up of static charges.

21.2 Installation/Mounting Variants

The transmitter is available in two different installation variants:

- E0 - for direct DIN rail mounting in control cabinets or similar enclosures
- E1 - specially designed DIN rail enclosure without cover strips, with extended DIN rail fastening
 - Installation in NIVUS field enclosure *ZUB0 NFW0 / ZUB0 NFWx x*
 - Additional installation of an Ex Separation Module pXT0 within the field enclosure possible



Pre-mounted assembly when ordered at the same time

If NivuFlow 600 (in installation variant E1) is ordered together with the Ex Separation Module pXT0 and field enclosure at the same time, the units are delivered pre-assembled and wired to each other via a connection/bus cable (ZUB0 TT KABEL 005).

CAUTION



NivuFlow 600 installation variant E0 not suitable for installation in NIVUS field enclosure

*Subsequent installation of a transmitter with installation variant E0 in a NIVUS field enclosure is not possible without **conversion** to installation variant E1. The conversion and the change of connection can be carried out by NIVUS.*

Subsequent Installation in NIVUS Field Enclosure

If a modified transmitter installation variant E0 (then corresponds to E1) and an Ex isolating module pXT0 are installed in a NIVUS field enclosure, the connection between the transmitter and pXT0 must be made in accordance with the specifications in the instructions "Technical description Ex Separator Module pXT0 - Transit Time" (see Chap. "1.1 Applicable Documentation").

When installing the transmitter and the pXT0 in the field enclosure, ensure the correct installation position. This is given by the separation on the inside of the enclosure cover. The display of the transmitter must be centred in the viewing opening of the enclosure cover. Minor corrections can be made by moving the unit on the DIN rail. The connection/bus cable (*ZUBO TT KABEL 005*) (Fig. 21-1 Pos. 2) between pXT0 (Fig. 21-1 Pos. 4; illustration similar) and transmitter (Fig. 21-1 Pos. 3; illustration similar) **must be laid above the partition** (Fig. 21-1 Pos. 1) in the housing cover of the field enclosure (Fig. 21-1 Pos. 5) **for explosion protection reasons**.

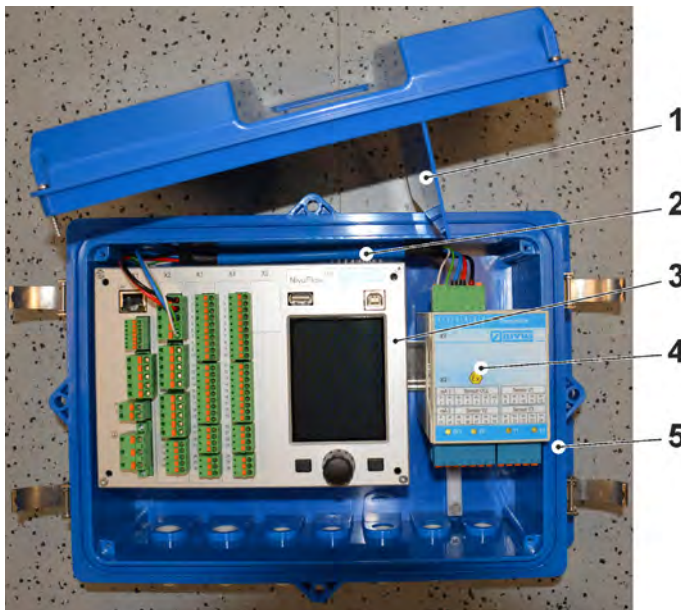

Fig. 21-1 Cable Routing in the Field Enclosure (Principle)

21.3 Selecting the Mounting Place

The NivuFlow with DIN rail mounting is designed for installation in control cabinets, switching boxes and mounting frames.

- Ensure sufficient ventilation at the mounting place. For example by means of fans or air vents.
- Make sure that access to any disconnecting devices (mains switches) is not impeded by the installation.

The transmitter can also be installed in on-site enclosures. Due to its protection class, however, the transmitter is not suitable for direct unprotected mounting on site. Use the optionally available field housing from NIVUS for this purpose.

The following precautions must be taken at the mounting place for safe installation:

- Protect the transmitter from direct sunlight. If necessary install a sunshade.
- Do not install the transmitter in the vicinity of strong electromagnetic fields (frequency converters, high-voltage lines, etc.).
- Observe the permissible ambient temperature (see Chap. "17 Specifications").
- Do not expose the transmitter to strong vibrations or mechanical shocks.

When selecting the installation location, avoid the following conditions under all circumstances:

- Corrosive chemicals or gases
- Radioactive radiation
- Installation close to footpaths or travel ways

21.4 Fastening the transmitter to a DIN rail in the control cabinet



Gather the required materials beforehand

*Mounting material and tools are **not** included in the scope of delivery.*

- For mounting use a DIN rail Type TS35 according to EN50022 with a minimum length of 140 mm.
 1. Fasten the DIN rail horizontally in the enclosure/control cabinet provided using at least two screws.
 2. Hook the transmitter into the DIN rail from below. The device locks into place by pressing lightly in the direction of the DIN rail.

The electrical installation and connection of the sensors can then be carried out.

21.5 Fastening the field enclosure and preparations for electrical installation



Gather the required materials beforehand

*The fastening material is **not** part of the delivery, but must be individually defined and compiled, depending on the installation location.*

After selecting a suitable installation location, the NIVUS field enclosure can be permanently mounted. The basic condition for the fastening is that it is secure, durable and stable.

Required Materials and Aids

- 6x fastening screw M5, M6 or other screws suitable for diameter 6.5 mm for fastening to the surface (selection of screw type and screw length depending on surface material/condition)
- Possibly 6x dowels (depending on the surface material/condition and the fastening screws used)

Preparatory Work

- Procedure:
 1. Select fastening screws (screw type/length) and accessories, taking into account:
 - the condition and load-bearing capacity of the surface at the installation location (wood, metal, concrete, masonry, etc.)
 - the need for dowels and, if necessary, other aids

Tip:
When determining the length of the screws, be sure to include the material thickness of the two fastening lugs (approx. 17 mm).
 2. If necessary, drill dowel holes at the installation location and insert dowels.

Fastening the Field Enclosure

- Procedure:
 1. Fasten the field enclosure (Fig. 21-2 Pos. 3) with the six pre-selected fastening screws through the through holes with diameter 6.5 mm (Fig. 21-2 Pos. 6) to the two side lugs.

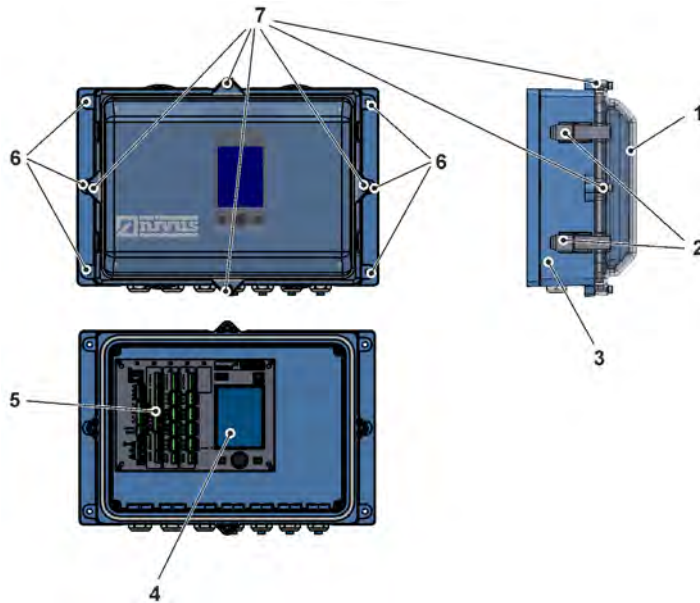

Fig. 21-2 Fastening the Field Enclosure

2. If present, remove the transport protection foil from the transparent enclosure cover (Fig. 21-2 Pos. 1).

Tip:

The protective foil will harden due to UV radiation and may not be able to be removed without residue later. The alteration of the protective foil can lead to severe optical impairments.

New transparent enclosure covers can be purchased from NIVUS and easily replaced by the user.

3. If available, mount the weather protection roof.

Preparing the field enclosure for electrical installation

🔄 Procedure:

1. To remove the transparent enclosure lid (Fig. 21-2 Pos. 1) from
 - Enclosure *ZUB0 NFW0* (with protection class IP67):
Open the four clamp locks on each side (Fig. 21-2 Pos. 2) and remove the enclosure cover.
 - Enclosure *ZUB0 NFW0 IP68 / ZUB0 NFW10 4PFAD* (with protection class IP68):
Remove the four cylinder head screws M4x25 (Fig. 21-2 Pos. 7) with the corresponding washers; open the four clamp locks (Fig. 21-2 Pos. 2) and remove the enclosure cover.
2. To remove the inner blue cover, unscrew the four round-head screws M3.5x25 in the corners and remove the cover. Now the transmitter, the display (Fig. 21-2 Pos. 4), the connection terminals (Fig. 21-2 Pos. 5) and, if available, the pXT0 are freely accessible.
3. Reassembly after connection is done in reverse order. Make absolutely sure that
 - the gaskets are free of dirt and have no damage and
 - the screws are all tightened firmly.
 Otherwise the IP67/IP68 protection class can **no** longer be **guaranteed**.

CAUTION



Do not install the overvoltage protection together with the transmitter in the ZUB0 NFWx field enclosure

Details see Chap. "25 Overvoltage Protection Measures".

22 Electrical Installation

DANGER



Danger by electric voltage

Disconnect the device from mains power.

When working on the electrical connections, there is a risk of electric shock. Necessarily observe the electrical data given on the nameplate.

Disregarding may lead to personal injury.



Note

Observe the national installation instructions.



Make sure that the following requirements are met:

1. Please note that installation may only be carried out by qualified personnel.
2. For electric installation follow the legal requirements of the respective country (in Germany: e.g. VDE 0100).
3. Observe further (country-specific) statutory standards, regulations and technical rulings.
4. For installation in wet environments or in areas where there is a risk of flooding, additional protection, e.g. by means of a residual current device (RCD), may be required.
5. Check whether the power supply of the units must be integrated into the EMERGENCY STOP concept of the plant; also with regard to explosion protection.
6. Before feeding the rated voltage the installation of transmitters and sensors must be completed. Verify whether the installation is correct.



The connection of the sensors is described from Page 49, the connection of the power supply on Page 45.

22.1 Connection to the spring-cage terminal blocks

All NivuFlow transmitters are equipped with pluggable spring-loaded terminals. The use of the pluggable spring-loaded terminal blocks allows easy pre-installation of the transmitter. This allows individual sensors, input and output signals, etc. to be checked and, if necessary, the transmitter to be replaced quickly.

The spring-loaded terminal blocks are suitable for the connection of single and multi-wire copper cables and are vibration-resistant.



To open the contacts on the spring-loaded terminal blocks, press the front orange elements with moderate pressure using a slotted screwdriver.

Pluggable and screwable spring-loaded terminal blocks are used to connect the power supply. Use a slotted screwdriver with a blade width of 3.0...3.5 mm to connect the power supply.



Important Notice

The spring-loaded terminal blocks may only be plugged and unplugged in a de-energised and voltage-free state.

DANGER



Danger by electric voltage

Multi-core cables (stranded wires) in the area of the AC power supply as well as the relay connections must be fitted with wire end ferrules with an insulated protective collar (plastic sleeve) in order to avoid danger from individual protruding cores.

Disregarding may lead to personal injury.

Spring-cage terminal block	Power Supply	Bus/ Network	Clamps O/I etc.
Cable cross-section (rigid) in [mm ²]	0.2...2.5	0.2...0.5	0.14...1.5
Cable cross-section (flexible) in [mm ²]	DC only: 0.2...2.5	0.2...0.5	0.14...1.5
Cable cross-section (flexible) with wire end ferrule blank in [mm ²]	DC only: 0.25...2.5	0.25...0.5	0.25...1.5
Cable cross-section (flexible) with wire end ferrule with insulated protective collar in [mm ²]	0.25...2.5	Not defined	0.25...0.5

Tab. 6 Cable cross-sections

The NivuFlow 600 / NivuFlow 600 WS transmitters are available in different **versions**.

⇒ See also Chap. "18.1 Device Versions".

All variants have identical terminal designations. These blocks are functionally assigned to the different connection areas. The versions T4/G4/TM/GM/TZ/GZ are equipped with additional terminal strips.

22.2 Terminal Wiring Diagrams

DANGER



Risk of Electric Shock

Never remove the spring-loaded terminal block from the terminal strip X1 (connections 15... 17).

This spring-loaded terminal block is used to connect the protective earth conductor and the AC power supply and is an integral part of the device. The device may only be operated with the spring-loaded terminal block screwed on.

Disregarding may lead to personal injury.

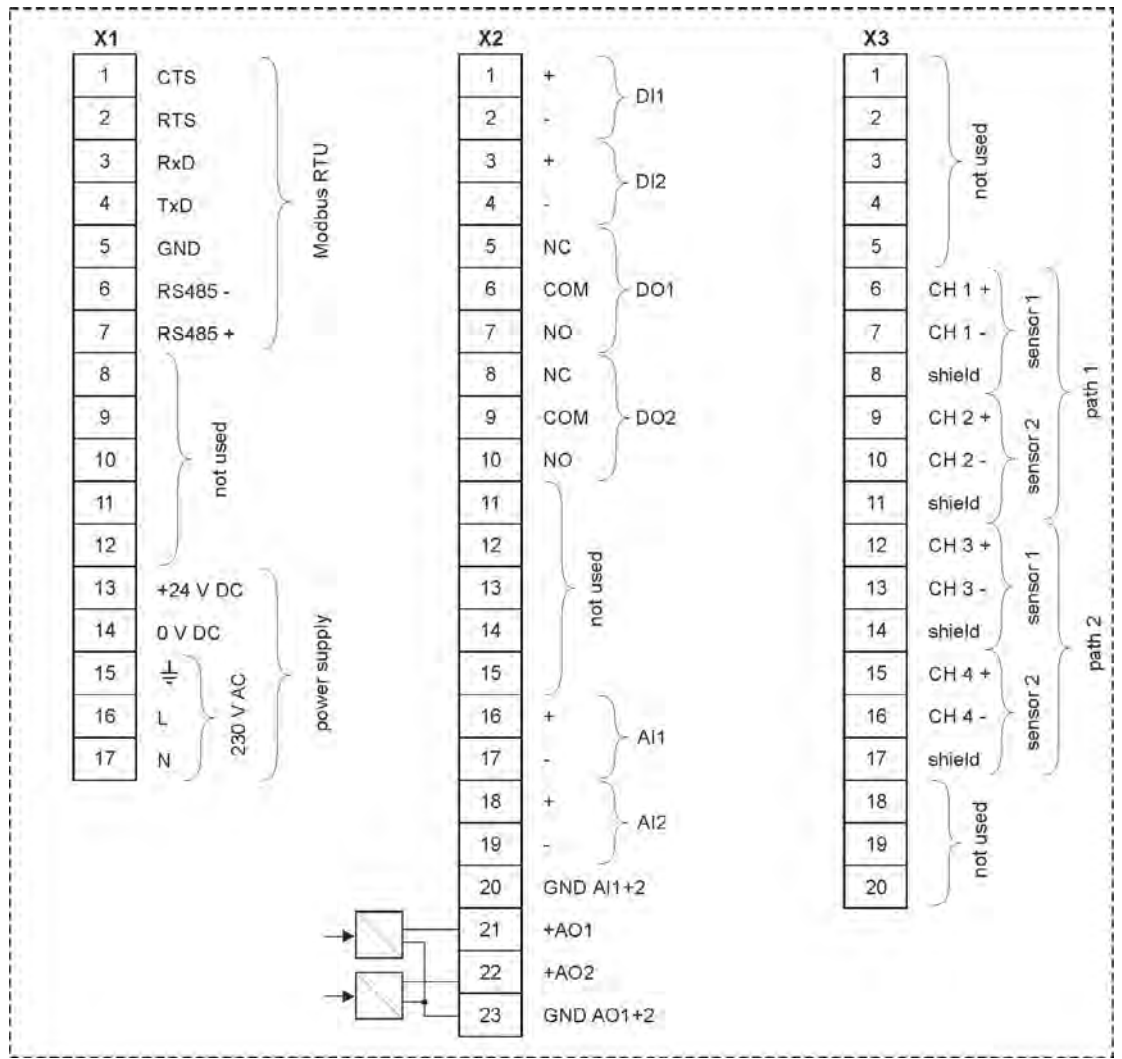

Fig. 22-1 Wiring diagram NivuFlow 600 Type T2/G2

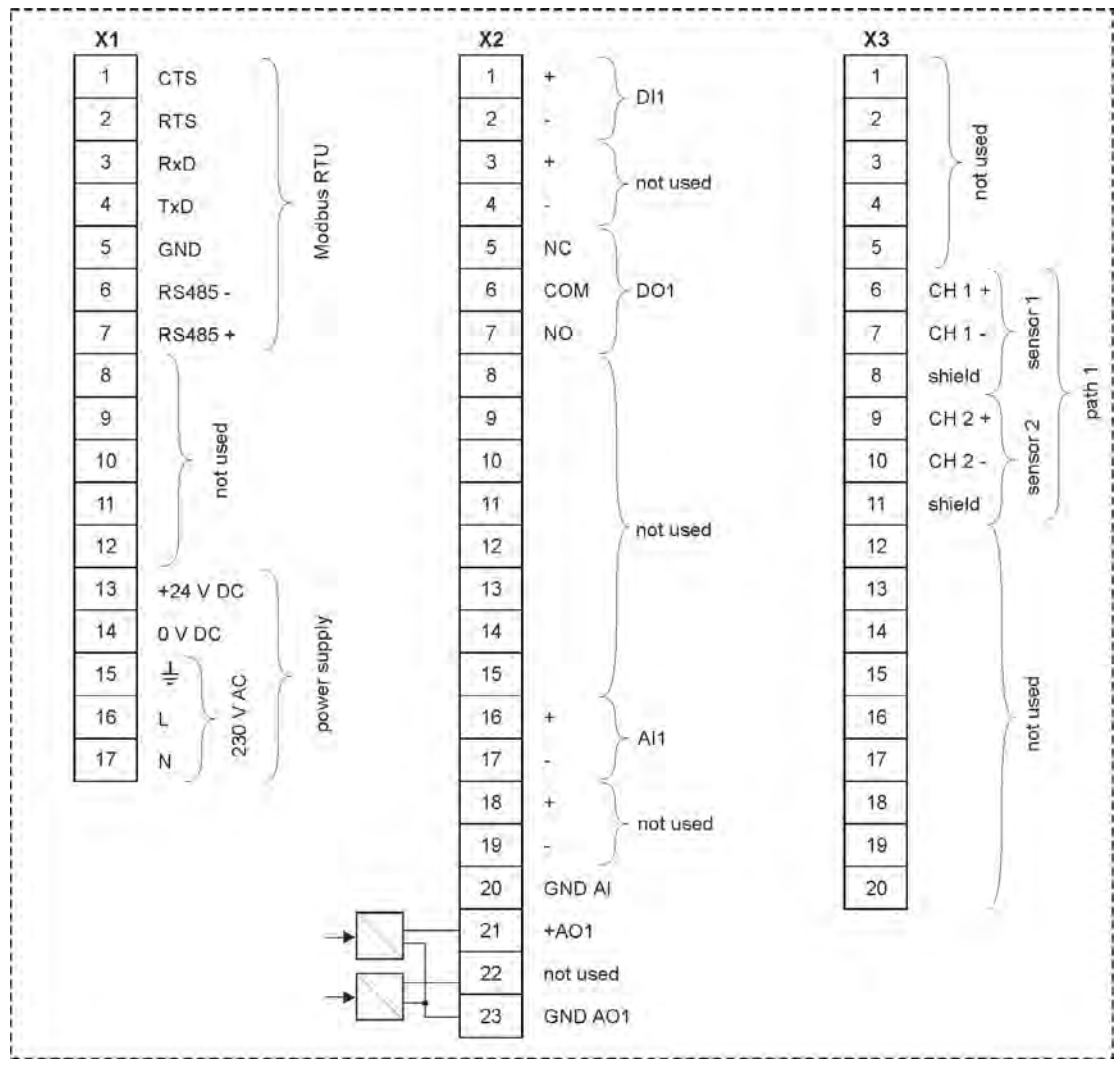

Fig. 22-2 Wiring diagram NivuFlow 600 WS Type TD/GD

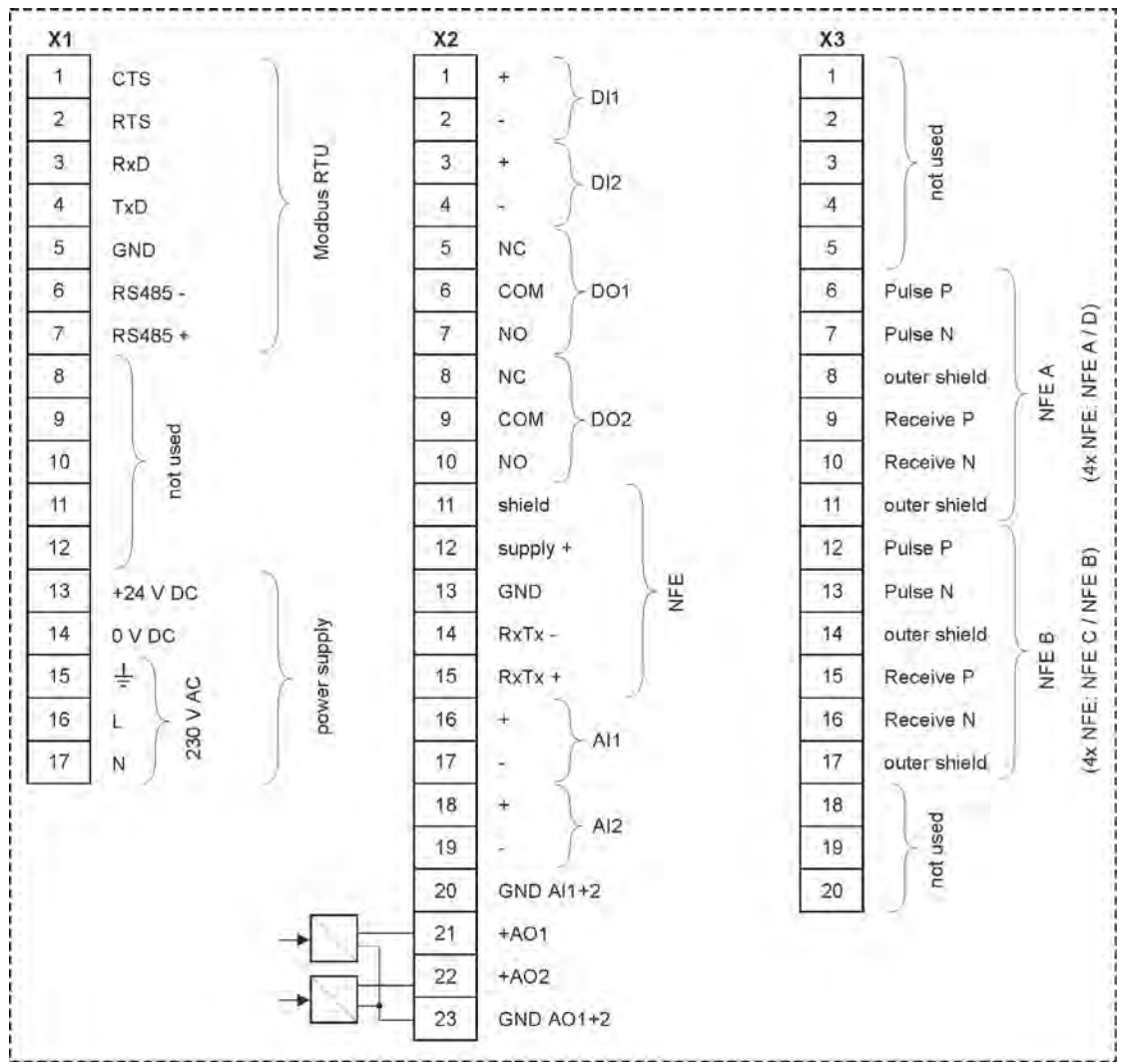

Fig. 22-3 Wiring diagram NivuFlow 600 Type TM/GM

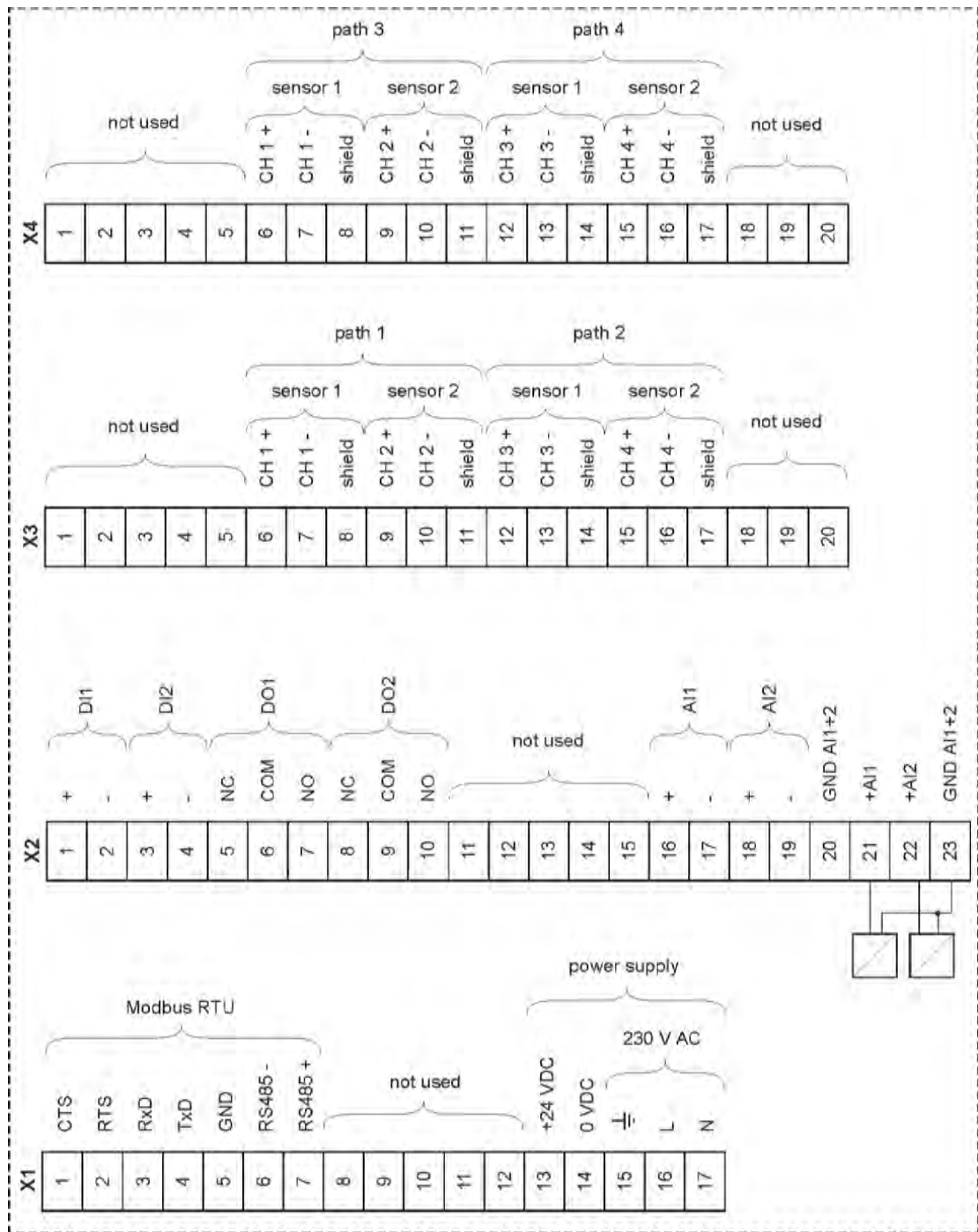

Fig. 22-4 Wiring diagram NivuFlow 600 Type T4/G4

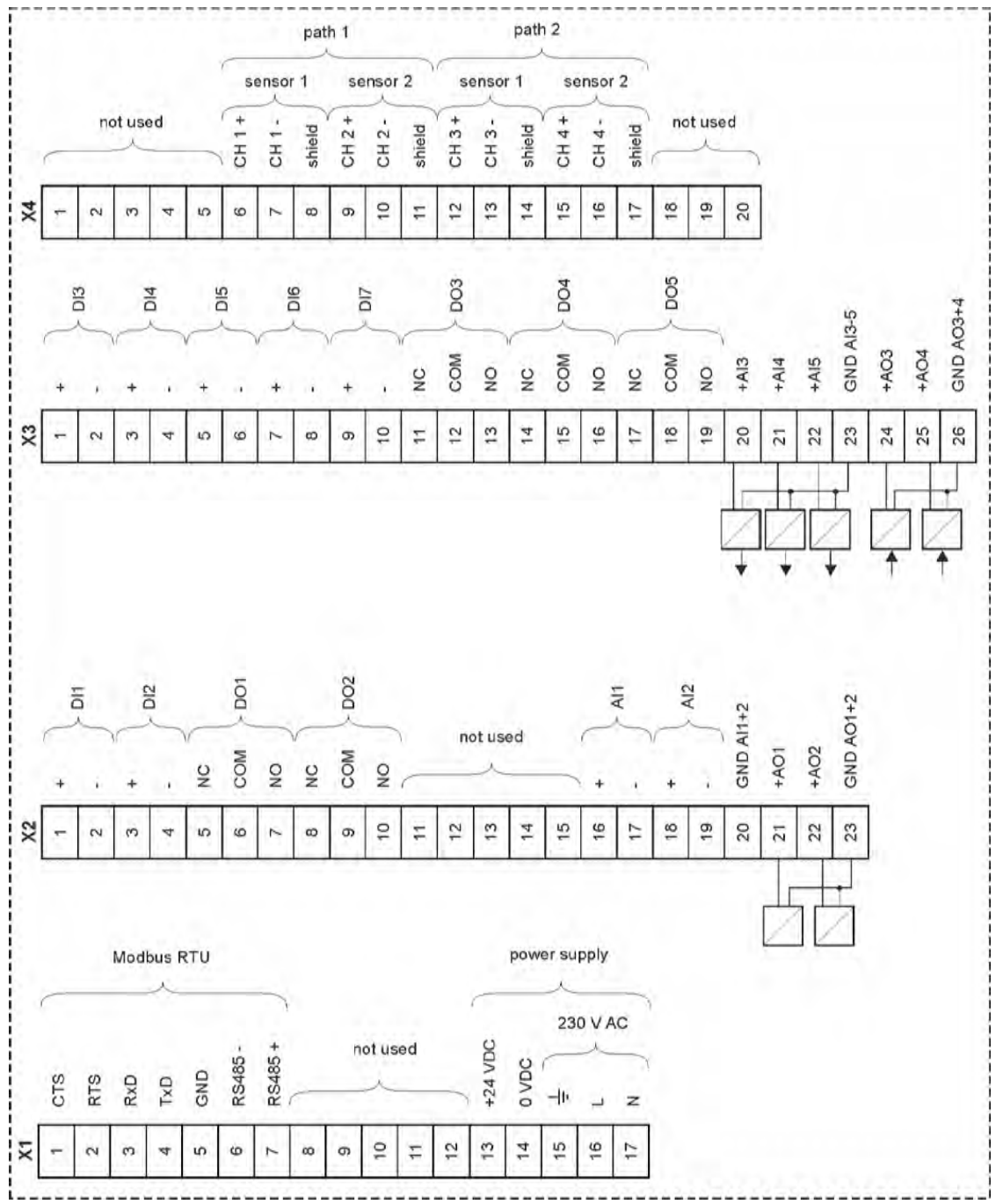

Fig. 22-5 Wiring diagram NivuFlow 600 Type TR/GR

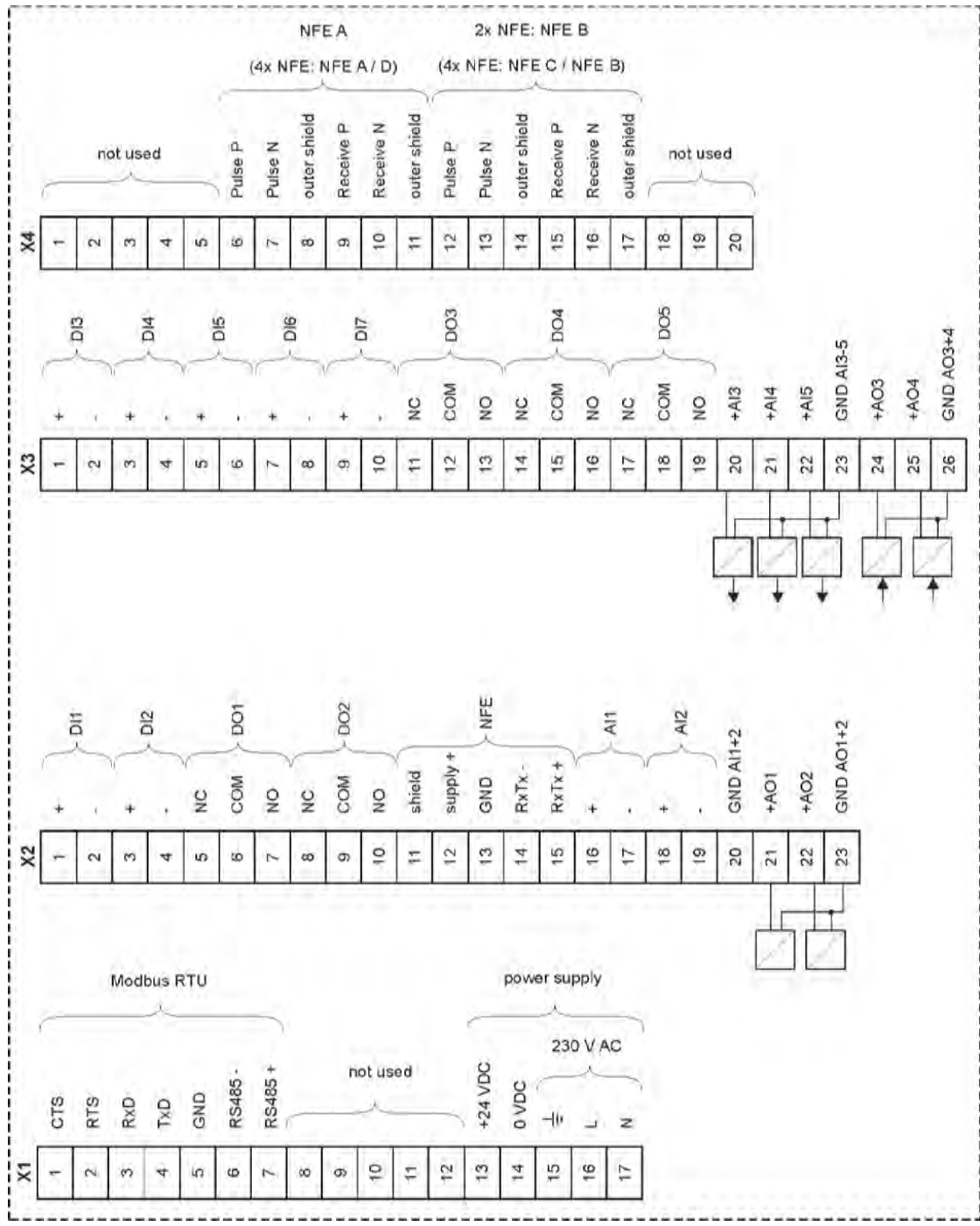

Fig. 22-6 Wiring diagram NivuFlow 600 Type TZ/GZ

22.3 Connecting the Power Supply

Depending on the type, the NivuFlow transmitter can be operated with 100...240 V AC (-15 / +10 %) or with 10...35 V DC.

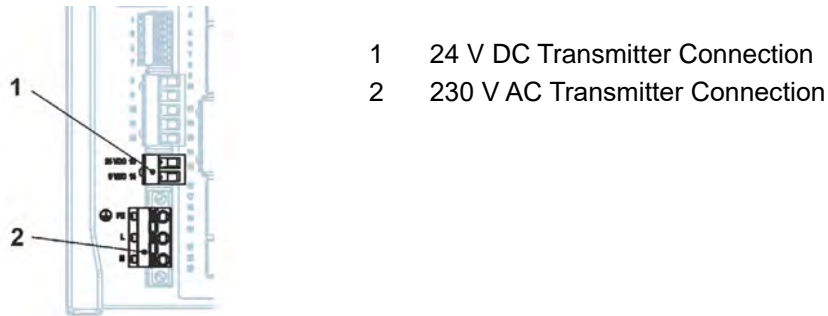

Fig. 22-7 Power Supply Wiring Diagram NivuFlow

DANGER



Risk of Electric Shock

Never remove the spring-loaded terminal block from the terminal strip X1 (connections 15...17).

This spring-loaded terminal block is used to connect the protective earth conductor and the AC power supply and is an integral part of the device. The device may only be operated with the spring-loaded terminal block screwed on.

Disregarding may lead to personal injury.



Use of Alternating Current - Direct Current

A 24 V **DC** unit must **not** be operated with **alternating current** (AC). Conversely, it is also **not** possible to operate a 230 V **AC** unit with 24 V **direct current** (DC).

22.3.1 DC Power Supply

The DC version can be operated directly on the 24 V DC network of a control cabinet.

Prerequisites

- Available input voltage at the input terminals:
 - With maximum load (20 W) at least 10 V
- Terminal voltage:
 - In no-load operation maximum 35 V

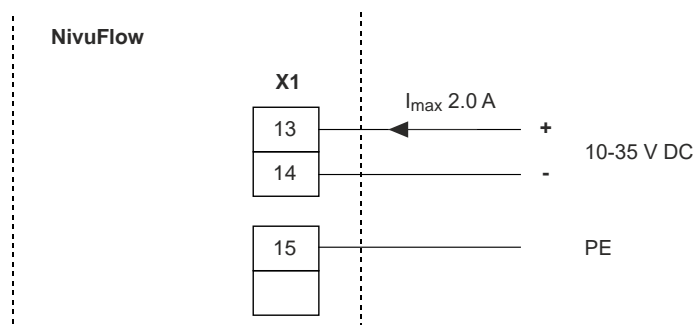

Fig. 22-8 Connection Power Supply DC Version

22.3.2 Power Supply AC

DANGER



Danger by electric voltage

The device may only be operated when the terminal blocks are screwed on tightly over the screw flange.

The spring-loaded terminal block X1 (terminals 15...17), for connecting the protective earth conductor and the AC power supply, is an integral part of the unit and not a plug connection. Disregarding may lead to personal injury.

DANGER



Danger by electric voltage

The power supply of the transmitter must be separately protected with a 6 A slow-blow fuse and disconnected independently of other circuit parts, e.g. by means of a circuit breaker with characteristic B. The disconnecting device must be marked in a suitable manner.

Disregarding may lead to personal injury.

The AC version of the NivuFlow can be operated directly from the low-voltage mains.

⇒ For AC supply requirements, see Chap. "17 Specifications".

Prerequisite

- Cross-section of the mains cables:
 - Minimum 0.75 mm²
 - According to IEC 227 or IEC 245

The AC version of the NivuFlow provides an auxiliary voltage of 24 V with a maximum load capacity of 80 mA at the terminals of the DC connection. This auxiliary voltage can be used, for example, in devices with integrated controller function for the necessary connection of the contacts of the slider end position or the torque switch to the digital inputs of the NivuFlow.

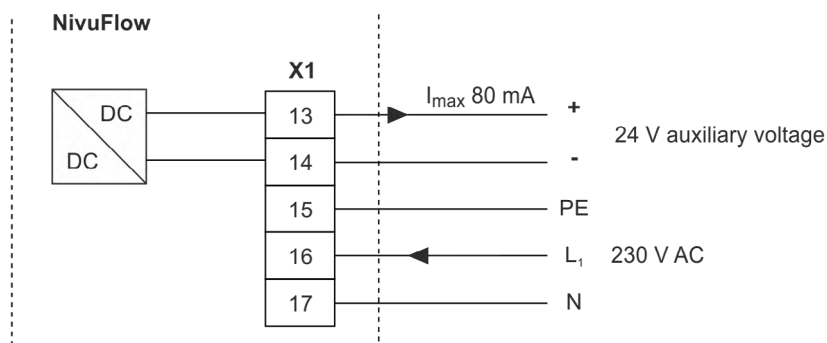

Fig. 22-9 Connection Power Supply AC Version

22.4 Relay

Falling below the specified minimum switching current reduces the reliability of the switching contact.

➡ It is essential to observe the specified connection and switching data in chapter "17 Specifications".

Relay 2 is designed as a bistable relay (i.e. it remains in the last activated position when de-energised) and is therefore not suitable as an error message relay.

DANGER



Danger by electric voltage – Contact protection measures

For relay voltages >150 V, the test pin connection of the relay terminal blocks does not guarantee touch protection according to the requirements of EN61010-1:2010.

Ensure additional contact protection measures in accordance with the applicable regulations and laws. For example: Open control cabinet/field enclosure only with tool or key, residual current circuit breaker or similar.

Disregarding may lead to personal injury.

DANGER



Danger by electric voltage - Protect relay contacts

If voltages in the low-voltage range (e.g. AC mains voltages) are switched via the relay contacts of the unit, these must be protected with 6 A slow-blow fuse. These contacts must be able to be switched off independently of other circuit parts.

A suitable protective earth connection must also be ensured for DC units to prevent the occurrence of dangerous voltages or currents.

Disregarding may lead to personal injury.

23 Installation and Connection of Sensors

The exact description for mounting the individual sensor types is described in the respective installation instructions.



Note

During assembly work, ensure that all work safety regulations are observed.

23.1 Sensor Installation Principles

The placement of the sensors is decisive for reliability and accuracy of the measurement results. Therefore, care must be taken to ensure good hydraulic conditions and a sufficient calming section at the installation site. The sensor types and their mounting must be determined individually, depending on the measuring point.



The conditions for selecting a calming section and mounting the sensors are described in the "Installation Instructions Transit Time Sensors".

The measurement place must be parameterised before or during installation. The corresponding preparation of the measurement place and its dimensions can be taken from the documents of the respective facility.

➔ The parameterisation of the measurement places is described in Chap. "Setting Parameters" starting on Page 83.

23.2 Installation of Clamp-On Sensors

Clamp-on sensors enable contactless measurement in closed and fully filled pipelines. The sensors are clamped onto a pipe from the outside. The liquid is not influenced by the measurement and the flow profile of the medium is not changed.



A detailed description of the sensors and their installation can be found in the "Technical Description Transit Time Sensors" and the "Installation Instructions Transit Time Sensors".

23.3 Installation of wetted Sensors



Hire a piping specialist

Wetted sensors should only be installed by a piping company or an installer. The tightness of the pipes must be guaranteed in any case.

The wetted sensors are installed through the pipe walls (pipe sensors) or inside the pipe (wedge sensors). They are in contact with the medium during the measurement in closed and fully filled pipes.



A detailed description of the sensors and their installation can be found in the "Technical Description Transit Time Sensors" and the "Installation Instructions Transit Time Sensors".

23.4 Path Arrangements

A basic distinction is made between "diametrical" and "chordal" in the arrangement of the measurement paths.

A "diametrical" arrangement of the measuring paths always leads through the centre of the pipe. A "chordal" arrangement crosses the pipe at any point and is preferably used when the measurement paths are to be positioned on several (parallel) levels of the pipe.

Below are some examples of "diametrical" path arrangements:

- \-Arrangement
- V-Arrangement
- W-Arrangement

Depending on the pre-setting and pipe diameter, not all arrangements are always available. The mounting distance between the two sensors is the "clearance".

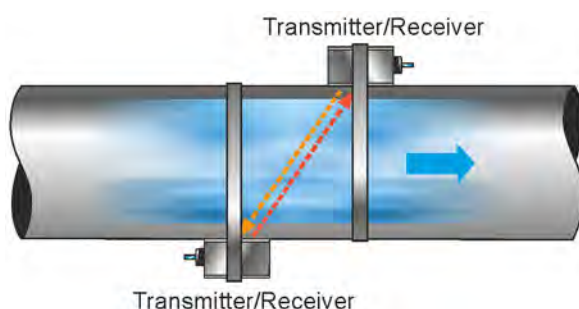

Fig. 23-1 Example "Diametrical \"-Arrangement

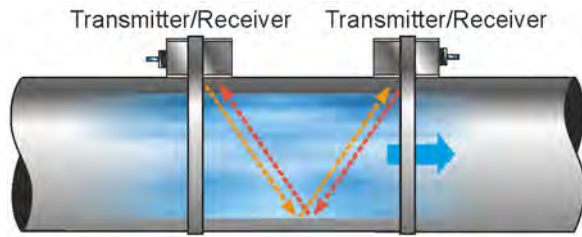

Fig. 23-2 Example "Diametrical V"-Arrangement

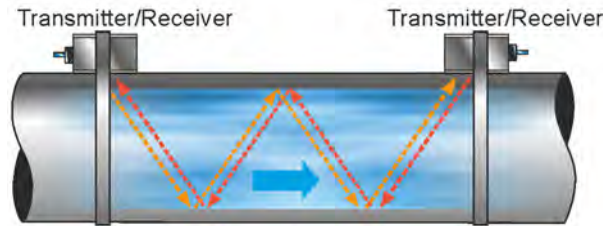

Fig. 23-3 Example "Diametrical W"-Arrangement

23.5 Cables and Cable Lengths for Sensor Connection



Cable designations may vary from country to country

The cable designations used may differ outside Germany. If you are unsure about the cable design (based on cable data sheets), ask NIVUS whether the respective cables are suitable.

Between Sensor and Transmitter

The cables connected to the sensors ex works must be used for the entire distance between the NIVUS sensors and the NivuFlow transmitter.

The signal cable is not intended for permanent direct burial. If the signal cable is to be laid in soil, concrete or similar, the signal cable must be laid in suitable protective pipes or protective hoses with a sufficiently dimensioned inner diameter.

The both sensors of **one** measurement path basically have the same cable length. The cables must not be extended or shortened.



A detailed description of the sensors and their installation can be found in the "Technical Description Transit Time Sensors" and the "Installation Instructions Transit Time Sensors".

23.6 Connecting Sensors to NivuFlow



Connectable Sensors see Chap. "16.3 Connectable Sensors".

The connected flow velocity sensors are used to determine the flow velocity.



A detailed description of the sensors and their installation can be found in the "Technical Description Transit Time Sensors" and the "Installation Instructions Transit Time Sensors".

23.6.1 Sensor connection with 1-path measurement / 2-path measurement

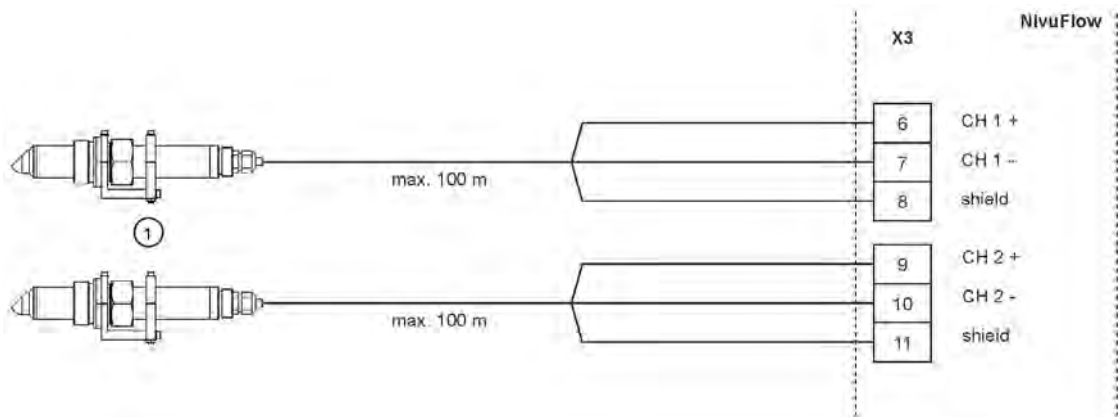

1 Connectable Flow Velocity Sensors

Fig. 23-4 Connection of 1 Pair of Flow Velocity Sensors

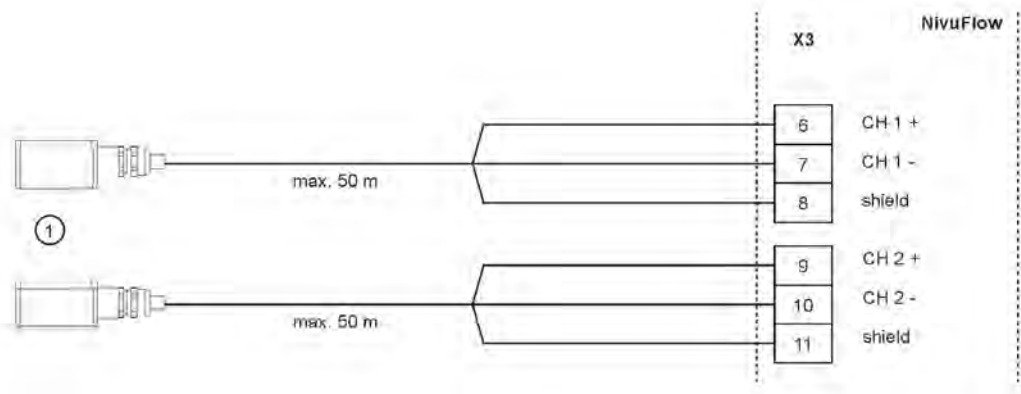

1 Connectable Clamp-On Sensors

Fig. 23-5 Connection of 1 Pair of Clamp-On Sensors

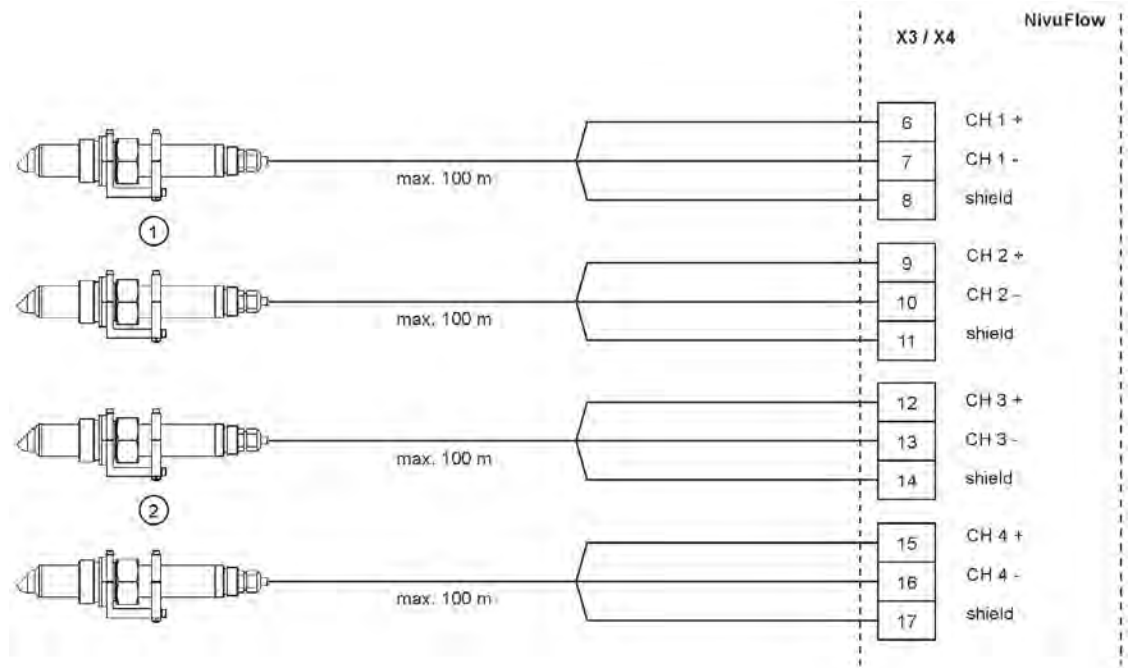

- 1 Connectable Flow Velocity Sensors Path 1
- 2 Connectable Flow Velocity Sensors Path 2

Fig. 23-6 Connection of 2 Pairs of Flow Velocity Sensors

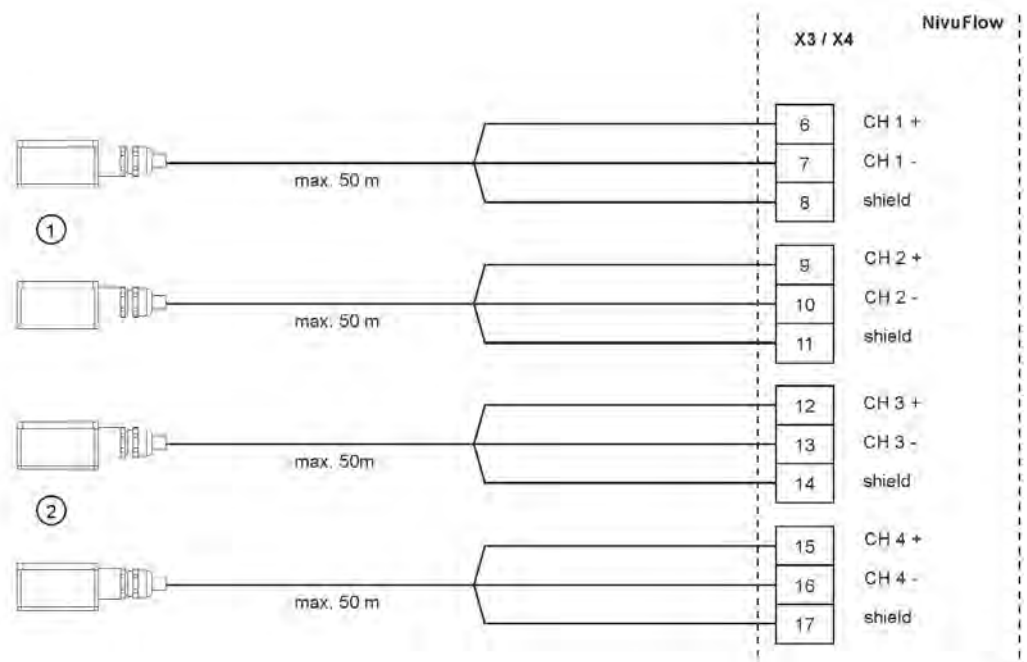

- 1 Connectable Clamp-On Sensors Path 1
- 2 Connectable Clamp-On Sensors Path 2

Fig. 23-7 Connection of 2 Pairs of Clamp-On Sensors

23.7 Connection using NFE Extension Modules



The connection of the transmitter and the sensors to an extension module or the connection of the extension modules to each other is explained in the "Technical Description Extension Module NFE".

The technical description is supplied with the extension module or can be downloaded from the NIVUS homepage.

When connecting extension modules, the measuring transducer (for types TM/GM/TZ/GZ) is supplied with a pre-assembled connection cable with potential bridges (Fig. 23-8 Pos. 1 and Pos. 2). The connection cable is used for the power supply or connection to the bus system.

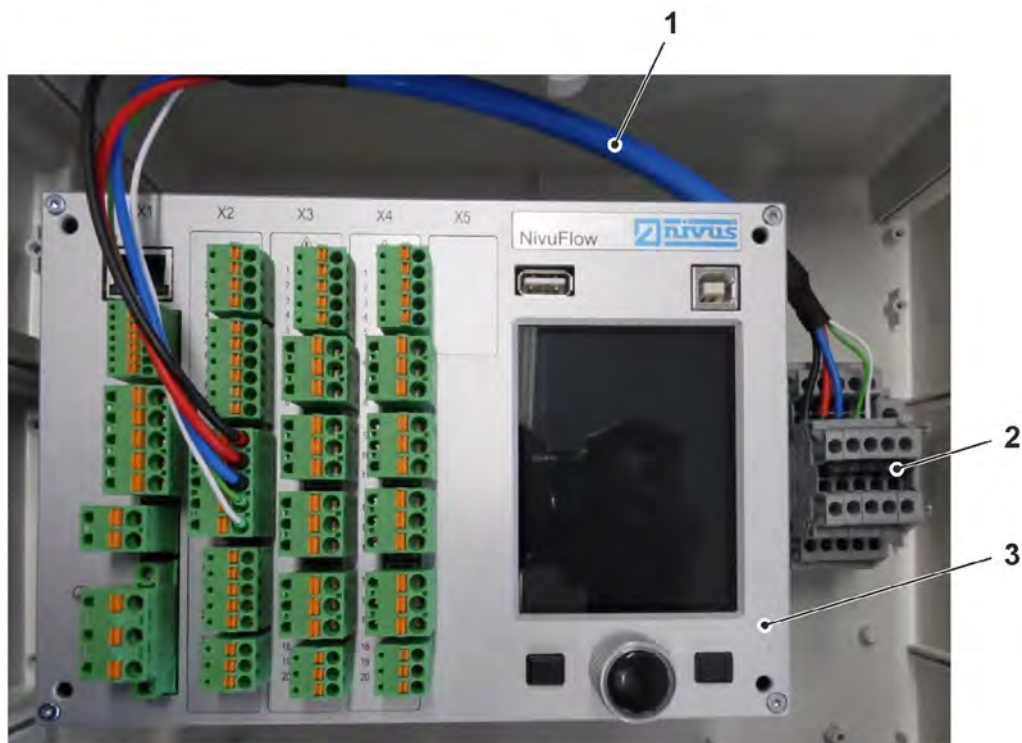

- 1 Connection Cable
- 2 Potential Bridges
- 3 Transmitter

Fig. 23-8 Connection cable with potential cable for extension module

24 Controller Mode (function can be added via licence)

24.1 General



Special Knowledge required

In order to set the controller function correctly and safely, it is essential to have a general basic knowledge of control technology and the parameters and setting procedures used in control technology.

A NivuFlow 600 type TR/GR/TZ/GZ transmitter is required to carry out volume control. The other types are not suitable for this, as they have too few inputs and outputs for the slide valve control or are not equipped with the internal software for the control functions.

If the Types T2/G2/T4/G4/TM/GM are nevertheless to be used for volume control, a suitable external controller is also required, which must then be programmed in accordance with the manufacturer's specifications.

Connecting the inputs/outputs to the connections of the control slide actuator

DI Slider Way CLOSED	DI4
DI Slider Way OPEN	DI5
DI Slider Torque CLOSED	DI6
DI Slider Manual	DI7
DO Slider Way CLOSED	DO4
DO Slider Way OPEN	DO5
AI Control Setpoint	AI5

Tab. 7 Assignment Inputs/Outputs

It is also possible to use an external reference value instead of the fixed internal reference value.

This external reference value is applied as a 4...20 mA input signal to analogue input 5 and thus allows, for example, remote control of the discharge volume or automatic basin management via suitable telecontrol devices with a 4...20 mA output signal.

It is also possible to assign an external signal (e.g. via a key switch) to a digital input of the transmitter in order to set the device to OFF mode (MANUAL mode) regarding its control functions during maintenance or repair work.

Use a knife gate valve or pipe gate valve with electric control drive and 3-point step control as the actuator.

Slide valves with an analogue control signal cannot be controlled.

NIVUS recommend the following **operating times** (running time from fully open to closed gate valve) for gate valve selection:

- ≤ DN300: min. 60 seconds
- ≤ DN500: min. 120 seconds
- ≤ DN800: min. 240 seconds
- ≤ DN1000: min. 300 seconds

Depending on the application, however, other settings may also be required.

The provision of the limit switches >OPEN< and >CLOSE< as well as the torque switch >CLOSE< is essential for the correct **control** and **error monitoring** of the slide valve. Apply these signals to the digital inputs of the transmitter.

Make sure that gold-plated versions are selected for the signalling contacts used for the input

signals wherever possible. These ensure reliable contact.

When using standard contacts, connect a signalling relay in between. The contacts of this signal relay must be designed in such a way that the input current of 10 mA is safely fed through to the digital input of the transmitter.

Feedback of an **analogue position indicator** of the gate valve to the transmitter is not intended.

The transmitter works as a 3-point step controller with surge detection, quick-close control and slide valve monitoring.

Digital outputs 4 and 5 are predefined for controlling the actuator:

- DO4: >Close Slide Valve<
- DO5: >Open Slide Valve<

Analogue input AI5 is defined for the input of an external reference value.



Assignment of inputs and outputs to the controller is defined

The assignment of the inputs and outputs to the controller is permanently defined and cannot be changed.

Reliable contacting of the limit switches must be ensured by selecting the appropriate contact material for the limit switches on the control slide.

24.2 Construction of a Control Section

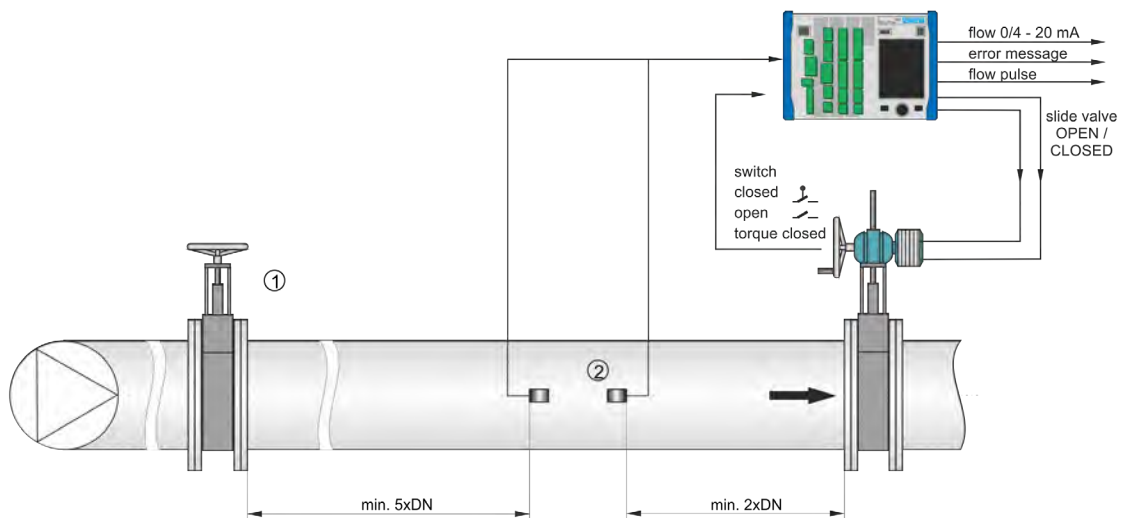

- 1 Manual Slide Valve
- 2 Clamp-On Sensor Pair

Fig. 24-1 Construction of a Control Section using the example of a Discharge Control System

24.3 Wiring diagram for controller mode

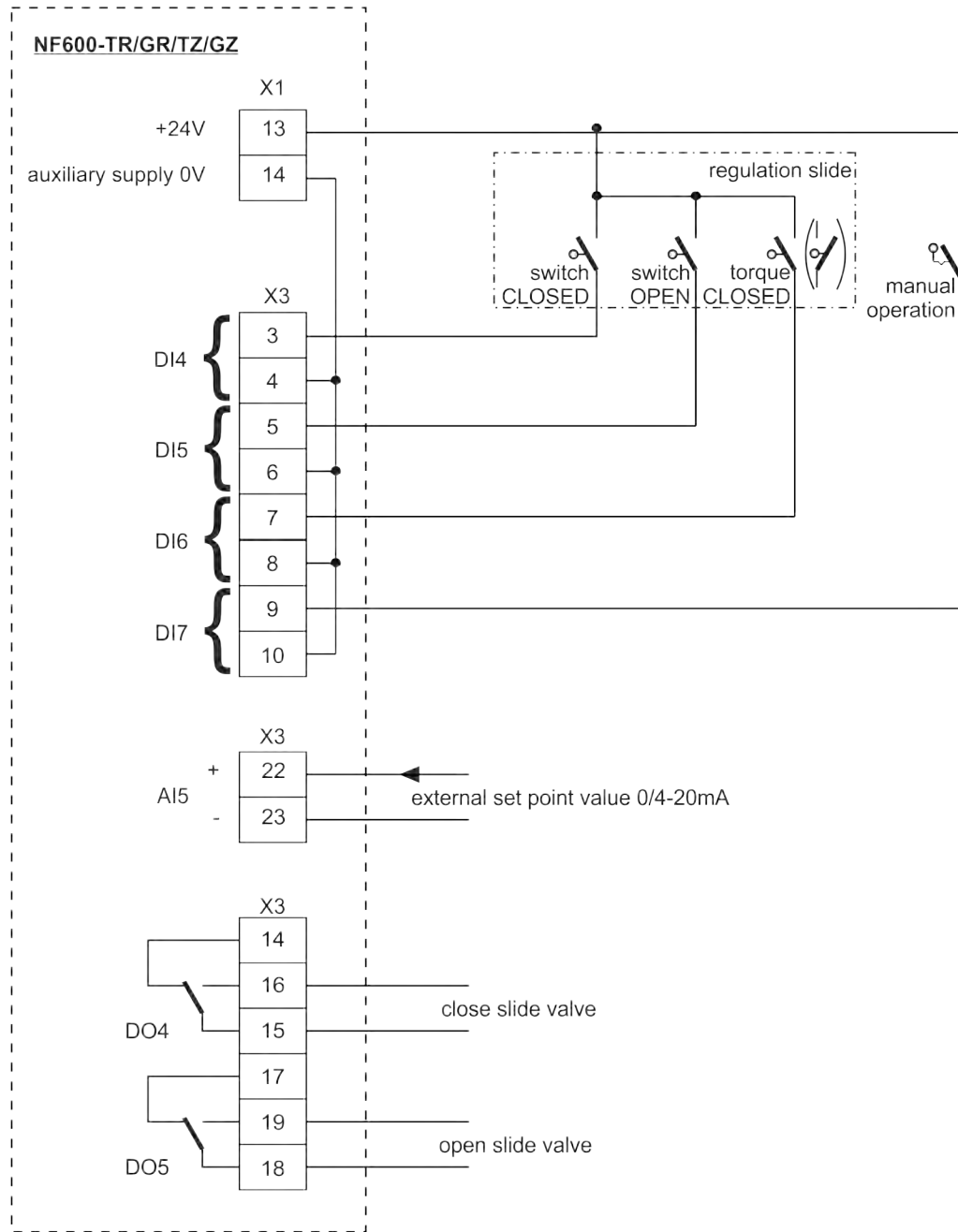

Fig. 24-2 Wiring diagram controller mode NF600 Type TR/GR/TZ/GZ

24.4 Control Algorithm



Activate all messages

Always use all three messages for slider control via the digital inputs.

Activating only one message can lead to malfunctions in control mode.

For the control mode, relay 4 is activated for the >Close Slider< function and relay 5 for >Open Slider<. This assignment **cannot** be changed.

The digital inputs for the position feedback messages are freely programmable.

For correct and error-monitored slider control, it is essential to use the >Way closed<, >Way open< and >Torque closed< messages of the slider actuator.

The controller can be operated with either an external or internal reference value. When using the external reference value, **always** apply it to AI5.

If a 4...20 mA signal is used as an external setpoint, this signal can be monitored for cable breaks and short circuits. In the event of an error, the transmitter then accesses the internal reference value. Therefore, when using the external reference value of 4...20 mA and error monitoring, **always** programme the internal reference value in addition.

The following relationship applies to the internal calculation of the **slide valve actuating time**:

$$\text{Actuating Time} = (\text{Reference Value} - \text{Flow Rate}_{\text{Actual Value}}) \cdot \text{P_Factor} \cdot \frac{\text{max. Slider Runtime}}{\text{max. Flow Rate}}$$



No detailed explanations

As extensive knowledge of control technology is required to parameterise the controller, no further explanations are given here.

If you are unsure, contact the NIVUS commissioning service.

25 Overvoltage Protection Measures

Depending on the operating conditions, it may be necessary to protect transmitters or their connections with additional overvoltage protection measures, for example against lightning strikes in overhead power lines.

Appropriate measures must be taken for the individual areas (power supply, mA inputs/outputs, communication interfaces and sensor connections).

- ➡ If an overvoltage event has occurred, it is essential to check the components of the overvoltage protection for proper functioning and replace them if necessary.



Sufficient overvoltage protection measures required

In principle, the system operator is responsible for protecting the devices and sensors.

NIVUS accept no liability for this (see also Chap. "5 Warranty").

DANGER



Do not install the overvoltage protection together with the transmitter in the ZUB0 NFWx field enclosure

The ZUB0 NFWx field enclosure is designed to accommodate a maximum of one NF6 and one Ex Separation Module pXT.

If overvoltage protection devices are installed at this location instead of the pXT, there is a risk of inadmissibly high voltages being induced directly onto the transmitter electronics when the protective device is triggered (due to the close proximity). When the overvoltage protection is triggered, a brief, strong magnetic field is generated.

This means that there is no reliable protection against overvoltage despite the use of overvoltage protection devices.

- Overvoltage protection devices must be installed at least 10...15 cm away from the transmitter.
- The cross-section of the overvoltage conductor must be at least 1.5 mm² and must not be longer than 1 metre. In addition, larger cross-sections must be selected or the arrester must be placed directly on an arrester strip.

The spatial separation of the unprotected side and the arrester from the protected side must be strictly observed: Spatial separation of the incoming and outgoing cables at the overvoltage protection element from the outgoing, protected cables.

Consequently, the respective overvoltage risks and measures should already be taken into account in the system concept of the measurement device installations. Appropriate on-site measures include, for example, laying the cables underground or absorbing mains-side interference outside the measurement device installation. These measures reduce the probability of an overvoltage event.

The transmitter earth connection is used to discharge high-frequency interference voltages, e.g. from sensor screens ("functional earth") and at the same time (in the case of low voltage) to protect against accidental contact ("protective earth"). Connecting the earth connection to the overvoltage discharge can lead to the overvoltage event to be discharged being coupled into the transmitter, at least partially, via this diversions.

The lack of a suitable discharge of the interference voltages can lead to increased noise values and thus to disturbed or **faulty measurements** or, in special cases, to the **interference of neighbouring electrical devices** by the transmitter.

If necessary, provide appropriate **HF interference suppression capacitors** (10...100 nF) to conduct interference from the transmitter enclosure (DIN rail/support rail) or directly from the sensor screens. Also take into account the currents and voltages that occur in the event of an overvoltage.

Depending on the design of the measurement system, direct earthing of the sensor screens can also be beneficial.

25.1 Overvoltage protection for the power supply

For the power supply, NIVUS recommend the EnerPro 220Tr (for supply from the mains 100-240 V AC) or EnerPro 24Tr (for 24 V DC power supply).



Observe connection direction

Ensure that the connection is on the correct side (p-side towards the transmitter) and that the cable feed is correct and straight. The down conductor (earth) must be necessarily routed in the direction of the unprotected side.

Incorrect connections disable the function of the overvoltage protection.

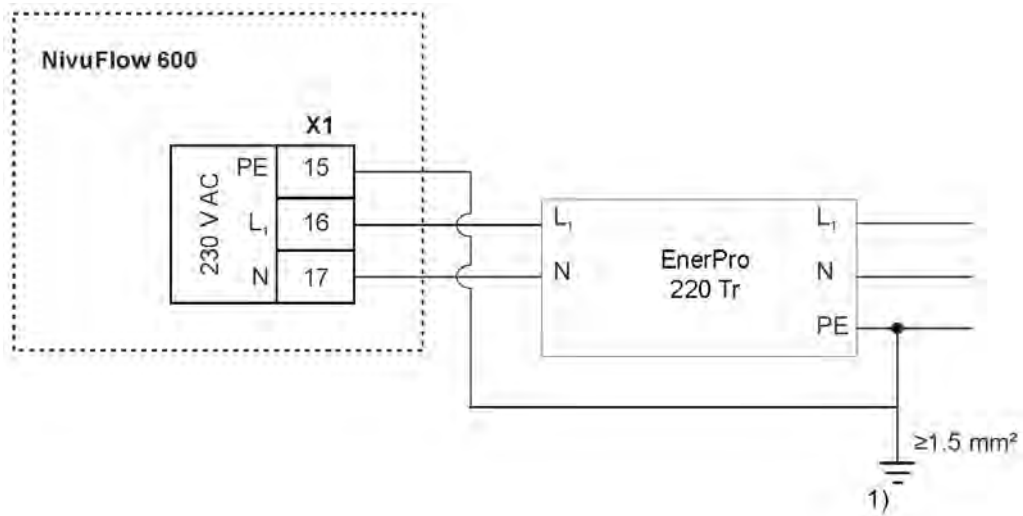

1) Low surge earthing resistance required

Fig. 25-1 Overvoltage protection for power supply AC general

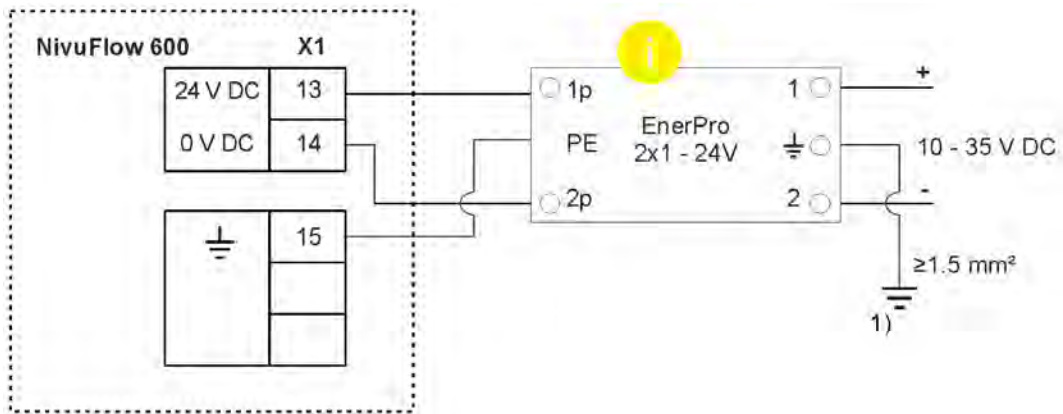

1) Low surge earthing resistance required

i Do not interchange the protected (p) and unprotected side of the surge protection

Fig. 25-2 Overvoltage protection for power supply DC general

25.2 Overvoltage Protection for mA Inputs/Outputs

For the mA inputs/outputs NIVUS recommend the type DataPro 2x1 24/24Tr.



Observe connection direction

Ensure that the connection is on the correct side (p-side towards the transmitter) and that the cable feed is correct and straight. The down conductor (earth) must be necessarily routed in the direction of the unprotected side.

Incorrect connections disable the function of the overvoltage protection.

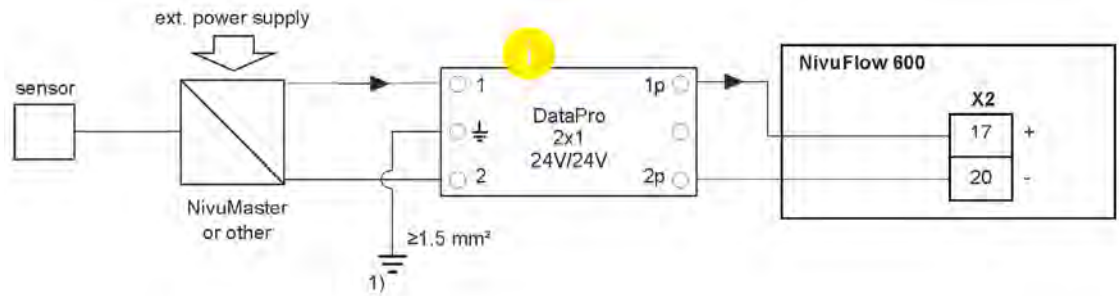

- 1) Low surge earthing resistance required
- i** Do not interchange the protected (p) and unprotected side of the surge protection

Fig. 25-3 Overvoltage protection analogue input from an ext. transmitter

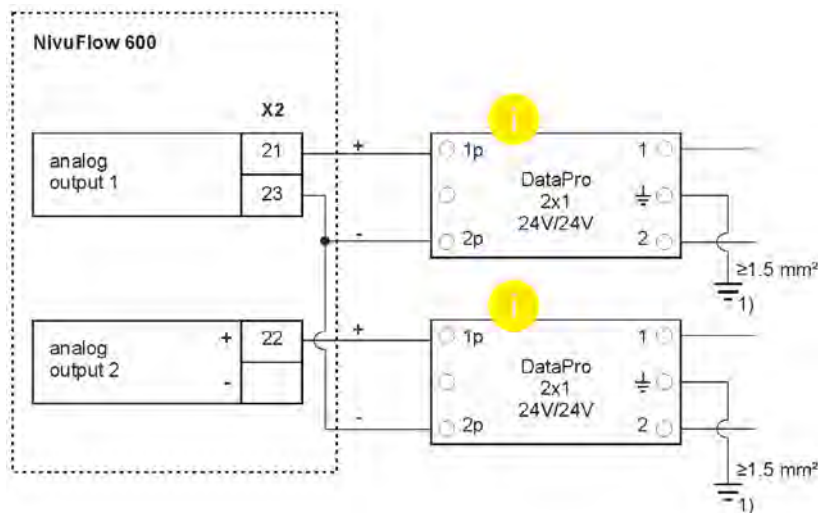

- 1) Low surge earthing resistance required
- i** Do not interchange the protected (p) and unprotected side of the surge protection

Fig. 25-4 Overvoltage protection for analogue outputs

25.3 Overvoltage Protection for Communication Interfaces

The communication interfaces must be protected in conjunction with the connected system and the overvoltage protection must be designed in accordance with the technical parameters of the system used.

➡ See Chap. "51 Accessories".

25.4 Overvoltage Protection for (Transit Time) Sensor Connections

25.4.1 Basic Protection - Potential Equalisation Cable

NIVUS recommend using a potential equalisation cable as a connection between the sensor enclosure and the control cabinet/transmitter earthing as basic protection for the transit time sensor connections. The potential equalisation cable prevents the flow of a transient equalising current via the transmitter and the cable screens.

It is important that the potential equalisation cable is sufficiently dimensioned (min. 4 mm²) and laid parallel to the sensor cables.

The following is an example of the use of a potential equalisation cable.

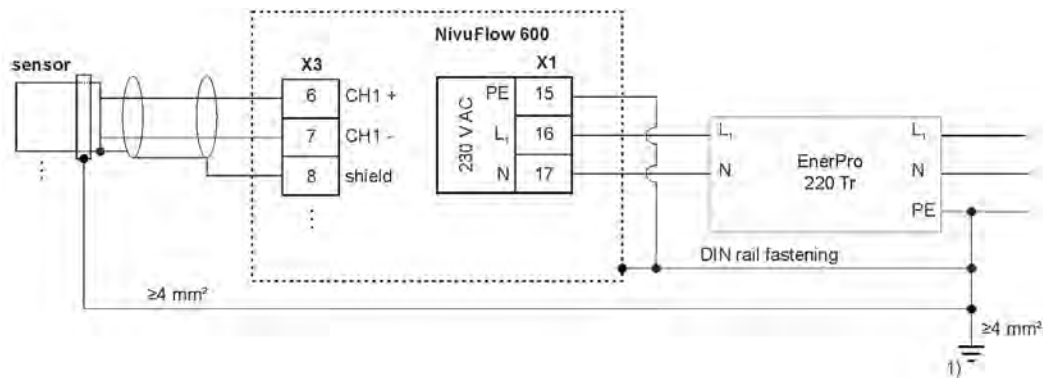

- 1) Low surge earthing resistance required

Fig. 25-5 Potential equalisation cable between sensor enclosure and control cabinet earthing

25.4.2 Extended Protection - Overvoltage Protection "SonicPro T"

In special applications, the use of "SonicPro T" overvoltage protectors is required for the transit time sensors.

Such applications are:

- The **occurrence of potential differences** (even for short periods) between the sensor enclosure and the control cabinet/transmitter earth cannot be avoided. This can be caused, for example
 - by excessive earthing resistance of the earthing electrode. This typically means that the leakage current of the mains supply overvoltage protection cannot be discharged to the required extent via the earthing connection of the control cabinet installation, resulting in a potential difference.
 - Or by an undersized or too long or poorly connected or missing potential equalisation cable to the runtime sensors.
 - Or by a combination of the factors mentioned above.
- The possibility of **overvoltage acting directly** on the enclosure of the transit time sensor. This effect can occur via the mounting device, the sensor cable or the medium (water-based liquids).



Install overvoltage protection on each sensor individually

*The "SonicPro T" surge protectors must be installed **individually** for **each** connected transit time sensor.*

Use of "SonicPro T" overvoltage protectors

The "SonicPro T" overvoltage protectors galvanically isolate the sensor signal connections of the transmitter from the sensor connection cables. The effectiveness of the modules is

therefore not limited to keeping overvoltage coupled in from the sensor side away from the transmitter; they can also limit the equalising current flowing to the sensors to a low level in the event of an overvoltage event on the supply network side.

CAUTION



Observe the maximum frequency 1 MHz

The SonicPro T overvoltage protectors are technically designed for maximum frequencies of up to 1 MHz.

At higher frequencies, damage to the overvoltage protection and other components cannot be ruled out.



Observe connection direction

Ensure that the connection is on the correct side (p-side towards the transmitter) and that the cable feed is correct and straight. The down conductor (earth) must be necessarily routed in the direction of the unprotected side.

Incorrect connections disable the function of the overvoltage protection.

The following illustration shows an example of an installation fed from the AC mains with "EnerPro" overvoltage protectors (to the mains supply) and "SonicPro T" (to the transit time sensors). The "EnerPro" overvoltage protection can also be installed inside the control cabinet, but the separate earthing connection "G" must be retained. The combination with "P" or "C" is highly risky in the event of an overvoltage. NIVUS here recommends local separation for reasons of overvoltage protection too.

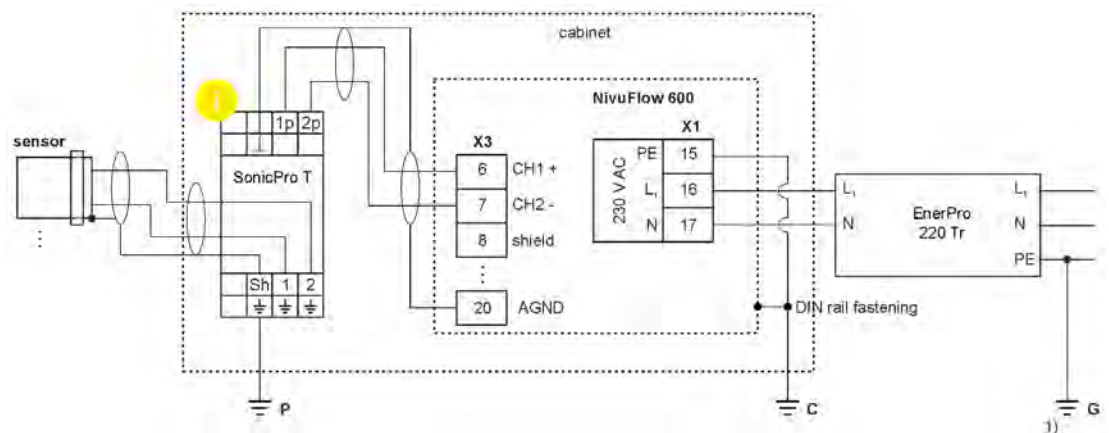

P Earthing connection for the "SonicPro T" overvoltage protectors on the sensor side

C Earthing connection for the transmitter installation

G Earthing connection for the AC mains overvoltage protection

1) Low surge earthing resistance required

i Do not interchange the protected (p) and unprotected side of the surge protection

Fig. 25-6 Example Installation Overvoltage Protection "SonicPro T"

Three different earthing connections are labelled in the drawing:

- P, C and G

It is important during installation that all three earthing connections, in particular the earthing connection "G", have a **low surge earthing resistance**, as high overvoltage leakage currents may flow.

If the surge earthing resistance of a poor earth electrode is 1 Ω, for example, a leakage current of 5 kA will lead to a peak voltage of 5000 V.

If this leakage current (e.g. via the DIN rail contact of an overvoltage element) is fed to the

control cabinet earthing, the potential of the transmitter earthing increases and an equalising current can flow via the sensor cables. Here, there is a risk that the sensor lines, the cables or the transmitter will be destroyed.

To achieve the low impedance of the earthing, for example, an earth electrode can be used. If this is not possible at the installation site, their mutual interference should be minimised by routing them to different independent earth electrodes.

In applications in which it can be assumed that no overvoltage can be coupled in from the sensor side, no leakage currents occur on the earth connection "P". This can then be connected directly to the transmitter earth "C".

All other **input/output signals** and **input/output voltages** leaving the switch cabinet must also be considered in relation to overvoltage. There is usually no galvanic isolation here, equalising currents can flow.

In applications that are particularly susceptible to overvoltage, an additional **low-capacitance isolating transformer** can further reduce the sensitivity to overvoltage events. However, this measure is only useful if the coupling of overvoltage into the control cabinet via the earth connection can be excluded.

DANGER

Protect connected expansion modules with "SonicPro T" overvoltage protectors

If expansion modules are used, these must be protected accordingly by overvoltage protection.

The procedure is described in the "Technical description Extension Module NFE".

Disregarding may result in damage to the system.

Modifying "SonicPro T" Overvoltage Protection

Depending on the situation on site, it may be necessary to modify the surge protection and, once during installation, to adapt it to the conditions on site.



Preparations in the Parameterisation

This modification is only possible after the (partial) parameterisation of the measurement place (defining the number of paths and ticking the box for the use of a SonicPro T overvoltage protection).

The measurement place is parameterised under >Application< / >Measurement Place<; see Chap. "34.1 Setting the Parameters in the Measurement Place Menu" or "34.2 Setting the Parameters in the Measurement Place Menu of the Combi Measurement Place".

Whether two red (150 Ω) or two blue (50 Ω) resistors must also be connected is determined by the transmitter under >Application< / >Diagnostics< / >v-Paths< (Fig. 25-7).

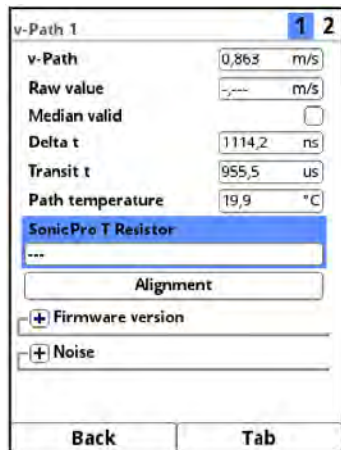
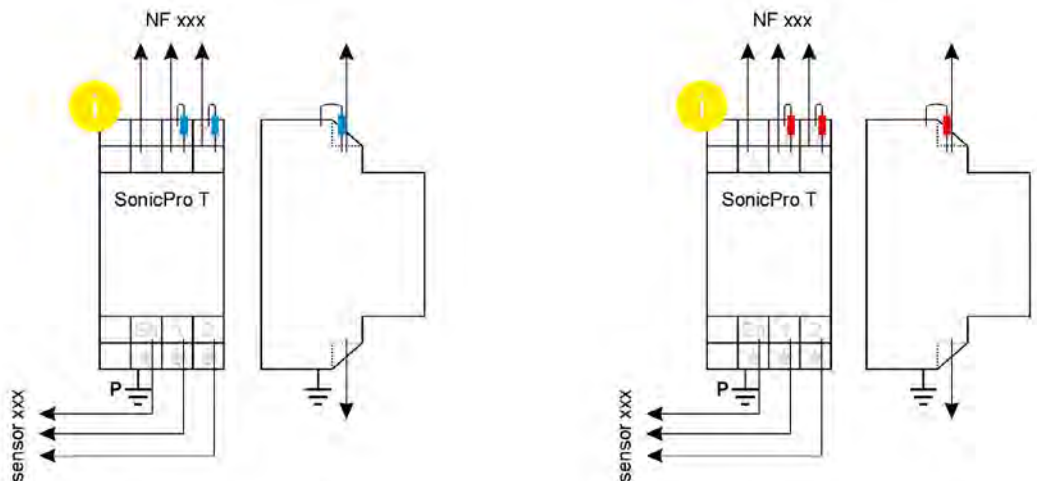

Fig. 25-7 Menu Application / Diagnostics / v-Paths

➡ Procedure:

1. Under >Application< / >Diagnostics< / >v-Paths< (Fig. 25-7), check which additional resistors must be connected to the SonicPro T overvoltage protection module: red or blue.
2. On the **protected** side, attach a resistor in the specified colour at 1p and at 2p from the lower terminal to the upper terminal according to Fig. 25-8.



i Do not interchange the protected (p) and unprotected side of the surge protection

Fig. 25-8 Modified Overvoltage Protection

3. Proceed with the overvoltage protection as described in Chap. "25.4.2 Extended Protection - Overvoltage Protection "SonicPro T"", using the upper terminals for further connection to the transmitter. If no additional resistors are required, the lower terminals are used for the connection to the transmitter.

Commissioning

26 Notes to the User

Before connecting and operating the NivuFlow, the instructions below shall be followed.

This instruction manual contains all information required for parameterisation and use of the device. The instruction manual is intended for qualified expert personnel. Appropriate knowledge in the areas of measurement systems, automation technology, control engineering, information technology and (waste)water hydraulics are preconditions for putting the NivuFlow into operation.

Read this instruction manual carefully to ensure proper functioning of the NivuFlow. Connect the NivuFlow according to the specified connection diagrams in Chap. "22.2 Terminal Wiring Diagrams".

If you have any questions regarding installation, connection or parameter setting, please contact our hotline at:

- +49 7262 9191-955

General Principles

Commissioning of the measurement system shall not be carried out before installation has been finished and verified.

Observe the information in this instruction manual to prevent incorrect or faulty parameterisation. Familiarise yourself with the operation of the transmitter using rotary pushbutton, function keys and display before you start parameterisation.

After connecting the transmitter and sensors (according to Chapters "22.1 Connection to the spring-cage terminal blocks", "23.6 Connecting Sensors to NivuFlow" and "23.7 Connection using NFE Extension Modules") the measurement place must be parameterised.

To do this, in most cases it is sufficient to specify:

- Measurement place geometry and dimensions
- Sensors used and their positioning within the application
- Medium Temperature
- Display units / language
- Function and span of analogue outputs as well as function and corresponding detailed parameterisation of digital outputs

The user interface of the NivuFlow is easy to understand. You can quickly make the **basic settings** yourself.

The parameterisation of the device should be carried out by NIVUS or by a specialist company authorised by NIVUS if one or more of the following conditions apply to you:

- Comprehensive programming tasks
- Difficult hydraulic conditions
- Special Channel Shapes
- Controller Settings
- Service specifications required a setting and error log
- Qualified personnel not specially trained or with little metrological experience

27 Principles of Operation

The entire operation of the NivuFlow is done via the control elements (see Chapter "2.2 NivuFlow Control Elements"). A rotary pushbutton and two function keys are available for parameterisation and entering required data.

The display shows at any time where entries are currently being made in the menu.

27.1 Overview Display

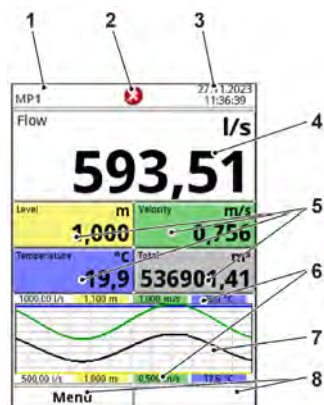

- 1 Measurement Place Name
- 2 Possible error message, system status information or display for active parameterisation or service mode
- 3 Date/Time
- 4 Display Area 1 (output field 1 for the flow rate; default setting)
- 5 Display Area 2 (output field 2...5 for level, average velocity, medium temperature and totaliser; default setting)
- 6 Automatic scaling for display area 3 (Pos. 7)
- 7 Display Area 3 (trend graph on level, velocity, medium temperature and flow rate)
- 8 Function displays for the assignment of the keys

Fig. 27-1 Main Screen (with default settings)

27.2 Using the Control Elements

➡ Select >Main Menu< by pressing the left function key.

1. Turn the rotary pushbutton until the desired menu or the corresponding parameter is highlighted blue.
2. Press the rotary pushbutton to go to the next parameter level or to enter the corresponding parameter.

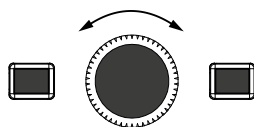

3. Repeat the procedure until the desired menu or parameter is reached.
Designations or **numerical values** can be entered for parameters.

➡ See Chap. "27.3 Input via Keypad" and "27.4 Input via Numeric field".

4. Press the left function key to exit the menus step by step.
The device continues to work in the background with the last set values during the parameterisation process.
The following prompt for **saving the changed parameters** does not appear in the display before the current parameterisation process has been completed and confirmed.

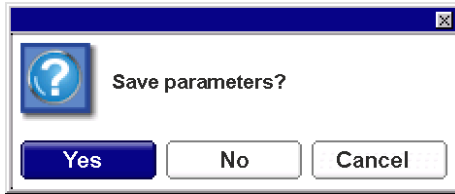

Fig. 27-2 Query for saving the parameters

5. Confirm entry with >YES<.
A **password request** follows.

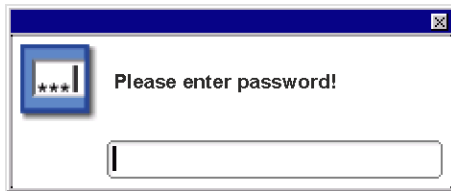

Fig. 27-3 Password request after setting the parameters

6. Enter password (default password "2718").
The NivuFlow takes over the new parameters at this point and continues to work with these values.

Depending on the parameterisation, the transmitter restarts the evaluation and calculation in the background. To prevent the display and analogue and digital outputs from going to "0" or putting out errors or limit violations that do not make any sense at this moment, the transmitter holds the display and output of the last measured value for a period of about 10...20 seconds after parameterisation has ended. This state is represented by showing an "H" (= Hold) in the upper line of the display (Fig. 27-4). As soon as the new valid measurement values are available, this "H" disappears and the transmitter returns to the display and output of the newly determined valid measurement values.

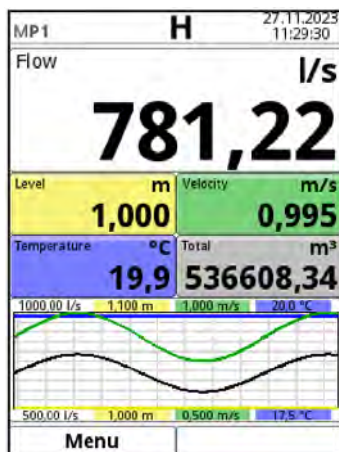

Fig. 27-4 Main Screen with Hold Symbol

27.3 Input via Keypad

Names or designations can be entered in some parameters. When selecting such a parameter, a keyboard field opens in the lower part of the display.



- 1 Selected Field
- 2 Multiple field (blue background)
- 3 Shift
- 4 Space
- 5 Backspace/delete button

Fig. 27-5 Keypad



Note

The use of the keypad is described here once. Later in the instruction manual, there is only a request to enter designations or names.

At the bottom left of the keypad is the shift key (Fig. 27-5 Pos. 3).

- The functions of this shift key are:
 - Upper case
 - Lower case
 - Special characters
 - Numbers
- These setting options allow individual designations (e.g. of the measurement place name).
- To **activate** the shift key, turn the rotary pushbutton until the shift key is highlighted in black.

➡ To **enter** designations (e.g. measurement place name), proceed as follows:

1. Press the rotary pushbutton - a keyboard field with individually selectable letters opens in the lower half of the display.
2. Turn the rotary pushbutton to navigate through the keyboard field. Letters with a blue background (Fig. 27-5 Pos. 2) have a multiple assignment. The assignment switches when the rotary pushbutton is pressed and held for approx. 1 second.
3. Press the rotary pushbutton until the desired letter is highlighted in black. The letter is transferred to the text field.
4. Repeat the procedure until the complete text (e.g. measurement place name) is stored in the display.

27.4 Input via Numeric field

In some parameters, dimensions or other numerical values can be entered. When selecting such a parameter, a numerical field opens in the lower part of the display (analogue to the keyboard field).



Note

The use of the numeric field is described here once. Later in the instruction manual, there is only a request to enter dimensions or numerical values.

- Press the rotary pushbutton - a numerical field appears.
 1. Enter the values digit by digit. The input is done in the same way as described for the keyboard field.
Pay attention to the use of decimal points in dimensions. The dimension of the canal profiles, for example, is specified in METER per default.
- To **enter further dimensions** after confirming (by pressing the rotary pushbutton), continue turning the rotary pushbutton until you reach the next possible dimension entry. Repeat the process as long as necessary.

27.5 Input Correction

- Incorrect entries are deleted letter by letter or digit by digit backwards with the backspace key:
 1. Open the keypad.
 2. Turn the rotary pushbutton until the >Back< arrow (back button) (Fig. 27-5 Pos. 5) is visible.
 3. Press the rotary pushbutton - the last letter or the last digit will be deleted. Repeat the process as often as necessary.
- Then continue writing until the correct designation or dimension is completely shown in the display, then confirm the entry with the right function key.
The designation or the numerical value is taken over by NivuFlow and shown in the display (e.g. for the measurement place name).

27.6 Menus

All menus are described in a logical programming sequence in Chapter "Setting Parameters" starting on Page 83.

Depending on the transmitter type, up to eight basic menus are available.
The basic menus can be viewed and selected by pressing the right function key.

In detail these are:

Application (MP1/MP2/Combi)	Guides commissioning personnel through the complete parameterisation of measurement place dimensions, sensor selection, analogue and digital inputs and outputs, controller functions and diagnostics.
Data	<ul style="list-style-type: none"> • Graphical representation of the progression of flow rate, level and (average) flow velocity • Tabular display of 24-hour daily totals • Storage of data, memory erasure • Saving and loading of parameters • Formatting the USB stick • Change in storage cycles and totals

System	<ul style="list-style-type: none"> • Retrieval of basic information (serial number, version, item number, etc.) on the transmitter and the connected sensors (required for queries at NIVUS) • Setting language, time/date format and displayed/stored (measurement) units under >Country Setting< • Setting the system time and time zones under >Time/Date< • Error messages under >Error Messages< • Service levels, password changes, activation of optional functions, reset and restart of the measurement system
Communication	Setting parameters for all communication interfaces of the NivuFlow such as TCP/IP, web server, data transmission, alarm messages as well as Modbus
User Indicator	<ul style="list-style-type: none"> • Input of basic parameters such as contrast, backlighting and dimming of the display as well as (partial) definition of the type of display in the main display • Setting the output fields (text, decimal places, etc.)
Connections	For transmitters with multiple measurement places, the assignments of the connection strips of the inputs and outputs as well as the DSP cards are assigned to the measurement places here. This menu does not exist for transmitters with only one measurement place.

Tab. 8 Overview Basic Menus

28 Measuring with Clamp-On Sensors

Measurements with clamp-on sensors can be carried out very easily and with little effort. The sensors are attached to the pipe from the outside.

Before installing the sensor for clamp-on measurement, the measuring section must be prepared and the measurement place parameterised.

The parameter settings of the measurement place include the following basic settings:

- Number and arrangement of paths
- Medium to be measured
- Pipe circumference or internal pipe diameter or outside pipe diameter
- Wall thickness
- Wall material
- If applicable, material of the inner lining

The transmitter calculates the position of the clamp-on sensors from these settings.

After parameterising the measurement place, the values for the sensor position can be read directly in the display of the operating module.



Observe the preparation measures of the measuring section in the "Mounting Instruction Transit Time Sensors".

29 Measuring with wetted Sensors

The wetted sensors are installed during the parameterisation of the measurement place.



Hire a piping specialist

Wetted sensors should only be installed by a piping company or an installer. The tightness of the pipes must be guaranteed in any case.

The parameterisation for a measurement place with wetted sensors is essentially the same as the parameterisation when using clamp-on sensors.

A distinction must be made when selecting the >Transit Time Mode<, the selection of the >Path Arrangement< offers more variants and when reading off the installation values, the >Distance Across< and the >Path Angle< also appear.

In addition, the values for >Distance across<, >Distance along<, >Path Length< and >Path Angle< are not just display values. They can be changed in the same way as the mounting angle. When a value is changed, the transmitter recalculates the dependent values and displays them.

This option is necessary because the sensors are installed and adjusted during parameterisation (installation depth and path angle).



Use in the drinking water sector

Some pipe sensors can also be used for drinking water applications and have drinking water approval (see "Technical Description Transit Time Sensors").

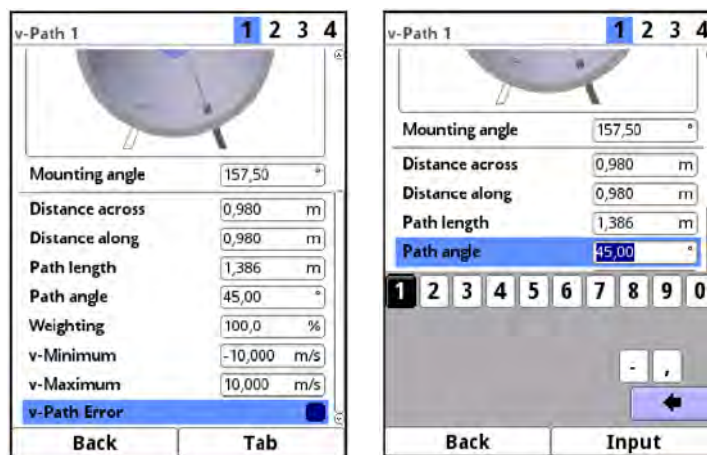

Fig. 29-1 Change of all values

Commissioning Examples

30 Parameterisation of a diametral 1-path Measurement

To parameterise a 1-path measurement, it is necessary to enter all data of the measurement place. Familiarise yourself beforehand with the Chap. "27 Principles of Operation" starting on Page 65. The parameterisation of the measurement place is described in Chap. "34.1 Setting the Parameters in the Measurement Place Menu" starting on Page 89.

30.1 Simple Parameterisation Procedure

Application Specifications in the Example:

- Clamp-On Sensors
- Stainless steel (steel)
- No inner lining
- No deposits in the pipe
- Path arrangement "Diametral \"
- 1 Path

➡ Procedure:

1. Select the "Menu" field (bottom left).
2. Open the >Application< menu.
3. Open the >Measurement Place< menu.
4. Enter the name of the measurement place and confirm with "Enter".
5. Select "Clamp-On" as transit time mode.
6. Specify the path arrangement ("Diametral \") and the number of paths (1 Path).

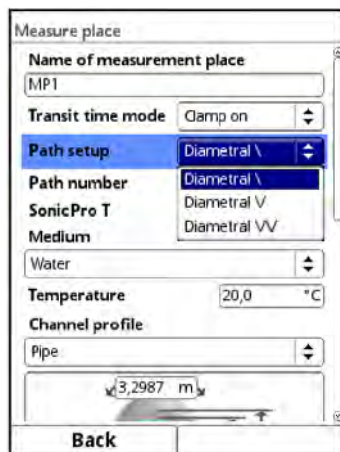

Fig. 30-1 Selection path arrangement



Notes on the Medium

If your medium to be measured is not in the displayed selection, select "Custom". Then another menu item opens in which you must enter, for example, the speed of sound of the medium.

Tip:

You can find lists of sound velocities on the Internet or contact NIVUS GmbH.

7. Use the selection menu to select/enter the medium to be measured and the current temperature of the medium.
8. Set the channel profile to "Pipe".
A pipe with four input fields is shown in the graphic area.
9. Enter the pipe data in the graphic area (example: DN1000). Two entries are sufficient for entering the pipe dimensions.
In this case internal diameter and wall thickness.



Fig. 30-2 Entering the pipe data

After entering the inner diameter and wall thickness, the transmitter automatically adds the outer diameter and the pipe circumference. The same happens after entering the circumference and wall thickness. The transmitter complements the remaining parameters.

10. Select the wall material using the selection menu (stainless steel).

No further entries are necessary - the subsequent parameters (lining, sludge level...) remain at their factory settings.

Whenever a relevant parameter is changed in the >Measurement Place< or >v-Paths< menu, the arrangement of the paths must be reinitialised. This allows the path lengths and sensor positions to be recalculated.

- ➡ To adjust the **settings for the measurement paths**, exit the >Measurement Place< menu.

1. Use "Back" to switch to the >Application< menu.
The following prompt appears on the display:



Fig. 30-3 Accept changed measurement place parameters

2. Confirm changed measurement place parameters and the new arrangement of the paths. After confirming >Yes<, the message "Initialised!" is shown in the display and the transmitter then goes to the >Application< menu.

- ➡ Procedure for **selecting the sensor** and **entering the mounting angle**

1. Select the >v-Paths< menu.
2. Select the sensor type used.
3. Specify the mounting angle according to the actual position (NIVUS recommend +45° or -45°) and confirm.

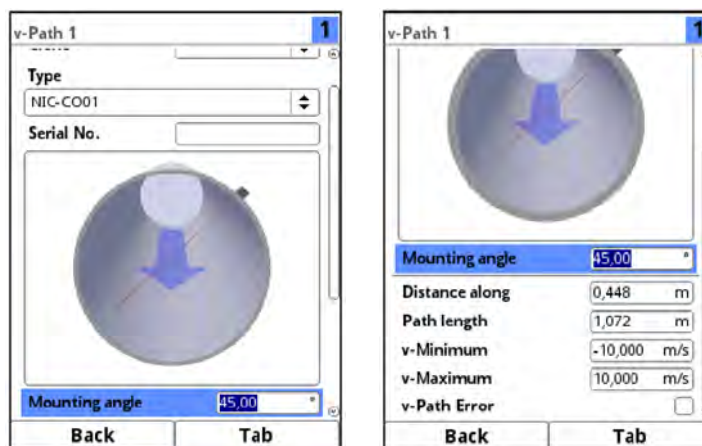

Fig. 30-4 Entering the mounting angle (clamp-on)

In the field >Lengthwise Distance< the mounting distance between the two sensors can be read in the display.

The distance is always the clearance between the two sensors.

All other parameters are read-only parameters or remain at the factory setting.

- After entering all necessary parameters for the measurement place, **save the parameters**:
1. Repeatedly press "Back" to exit the menu until >Save Parameters?< appears on the display.
 2. Confirm with >Yes<.
 3. Enter the password, the confirmation "Parameter saved!" is shown.
The transmitter switches to the main display and operates with the newly entered parameters.



Fig. 30-5 Save Parameters

30.2 Extended Parameterisation Procedure

More Specifications in the Example:

- Pipe with inner lining
- Deposits in the pipe (unusual with clear medium, but theoretically possible)

For pipes with inner lining:

- Procedure:
1. Carry out steps 1 ("Menu" field, Page 71) to 10 ("Wall Material"; Page 72) inclusive as described in Chap. "30.1 Simple Parameterisation Procedure".
 2. Select the >Lining< Material.
The thickness of the lining is now shown in the graphic area. For the calculation **with** lining, the transmitter requires this additional value.
 3. The thickness of the lining is now specified in the graphic area.
 4. If there are also deposits in the pipe, enter the corresponding value for >Sludge Level< and confirm.
The transmitter subtracts this sludge level from the total wetted hydraulic area when calculating the flow.
 5. To save the entries, select "Back" and agree to the change/arrangement of the paths with >Yes<.
 6. Menu >v-Paths<: Select sensor and enter the actual mounting angle.
Here you can read the >Distance along< and the >Path Length< for mounting the clamp-on sensors.

Main Screen

Quick Access

In addition to displaying the values themselves, the main screen also allows for direct access to the most important setting parameters.

The quick access enables to directly jump to important individual menus without having to go through the (sub)menus of the parameterisation. It hence serves as quick and uncomplicated check of the individual sensors involved in the measurement.

Quick diagnosis, uncomplicated parameter adjustment and adjustment are possible by using the quick access. Direct queries for basic device data such as serial and article numbers as well as the firmware version of the transmitter and the connected sensors are also possible in just a few steps.

31 General Overview



Note on the Displays and Descriptions in the Manual

Depending on the equipment/transmitter type, the descriptions and display illustrations may differ from those shown in the instruction manual.

Only types T4/G4/TM/GM have multiple measurement places or a combi measurement place. The same applies to the equipment of a flow controller for types TR/GR/TZ/GZ.

These illustrations and descriptions are not valid for the other transmitter types.

The following information is provided in the **top area** of the display:

- Measurement Place Name
- Date (alternatively 1, 2, 3; see Fig. 31-2)
- Time (alternatively 1, 2, 3; see Fig. 31-2)

The **red full circle with a white cross** in the top display area indicates pending errors in the system or individual sensors.

The **service key** in this area indicates that the password has been entered within the last six hours and that all further **parameter changes** can be saved **without** having to enter the **password** again. The six-hour period begins when the password is entered once and ends automatically.

If a number is also displayed directly next to the service key, the transmitter is in service mode. This is usually the case when a NIVUS service technician has access to the transmitter.



See also Chap. "32.1 Save Parameters" and "27.2 Using the Control Elements".

In operation mode (with factory setting), the transmitter displays the following important measured values in the **main area**:

- Flow Rate
- Level
- Velocity (average calculated velocity)
- Medium Temperature
- Grand Total

The **bottom part** of the display shows a trend graph (hydrograph) and the assignment of the two control keys.

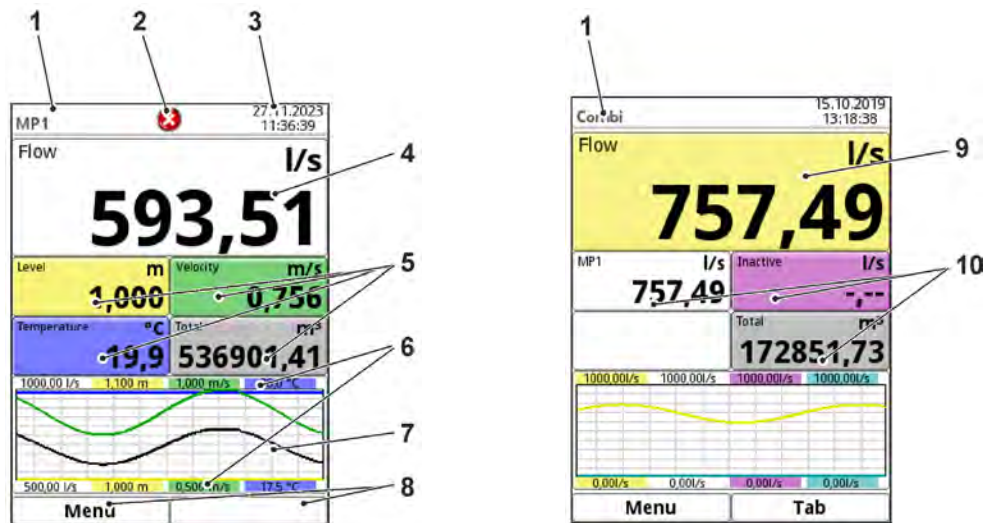

- 1 Measurement Place Name
- 2 Possible error message, system status information or display for active parameterisation or service mode
- 3 Date/Time
- 4 Display Area 1 (output field 1 for the flow rate)
- 5 Display Area 2 (output field 2...5 for level, average velocity, medium temperature and totaliser)
- 6 Automatic scaling for display area 3 (Pos. 7)
- 7 Display Area 3 (trend graph on level, velocity, medium temperature and flow rate)
- 8 Function displays for the assignment of the keys
- 9 Display Area 4 (output field 6 for the flow rate of the combi measurement place)
- 10 Display Area 5 (output field 7...9 for the flow rates of measurement place 1 and measurement place 2 and for the combi measurement place total)

Fig. 31-1 Main Screen Overview (right illustration for Type T4/G4/TM/GM)

With Types T4/G4/TM/GM with multiple measurement places the **main screen switches** back and forth between the active measuring points, provided that switching is activated under >Switch Main Screen< (see Chap. "38 Parameter Menu Display"). Clicking on the display fields interrupts the switching process.

It is possible to scroll **manually** between the individual measurement places using the **tab key**.

Direct access to the most relevant settings and information:

- ➡ Rotate the rotary pushbutton until the selected field is indicated black.
- ➡ Press the rotary pushbutton: the dialogue window of the according section opens.

As soon as the display fields are selected (shown in black), the numbers 1...3 are displayed at the top right of the T4/G4/TM/GM types instead of the date and time:

- 1 - Measurement Place 1
- 2 - Measurement Place 2
- 3 - Combi Measurement Place

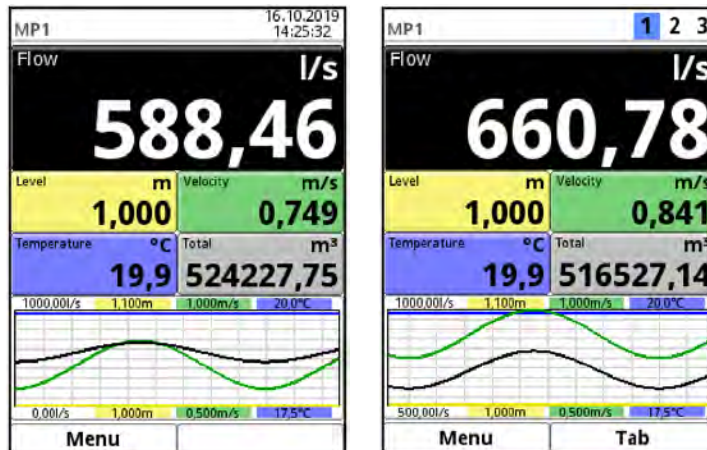

Fig. 31-2 Selected Screen Flow (right illustration for Type T4/G4/TM/GM)



Note

After changing system-specific parameters, the changes must be saved for them to take effect.

31.1 Display Field Flow of Measurement Places 1 and 2

After activating the dialogue window by pressing the rotary pushbutton, the individual menus (Information, Diagnostics, Settings, Display and Error Messages) can be accessed via the pop-up menu (see Chap. “36.1 Information”, “Diagnostics”, “34.1 Setting the Parameters in the Measurement Place Menu”, “38 Parameter Menu Display” and “36.4 Error Messages”).

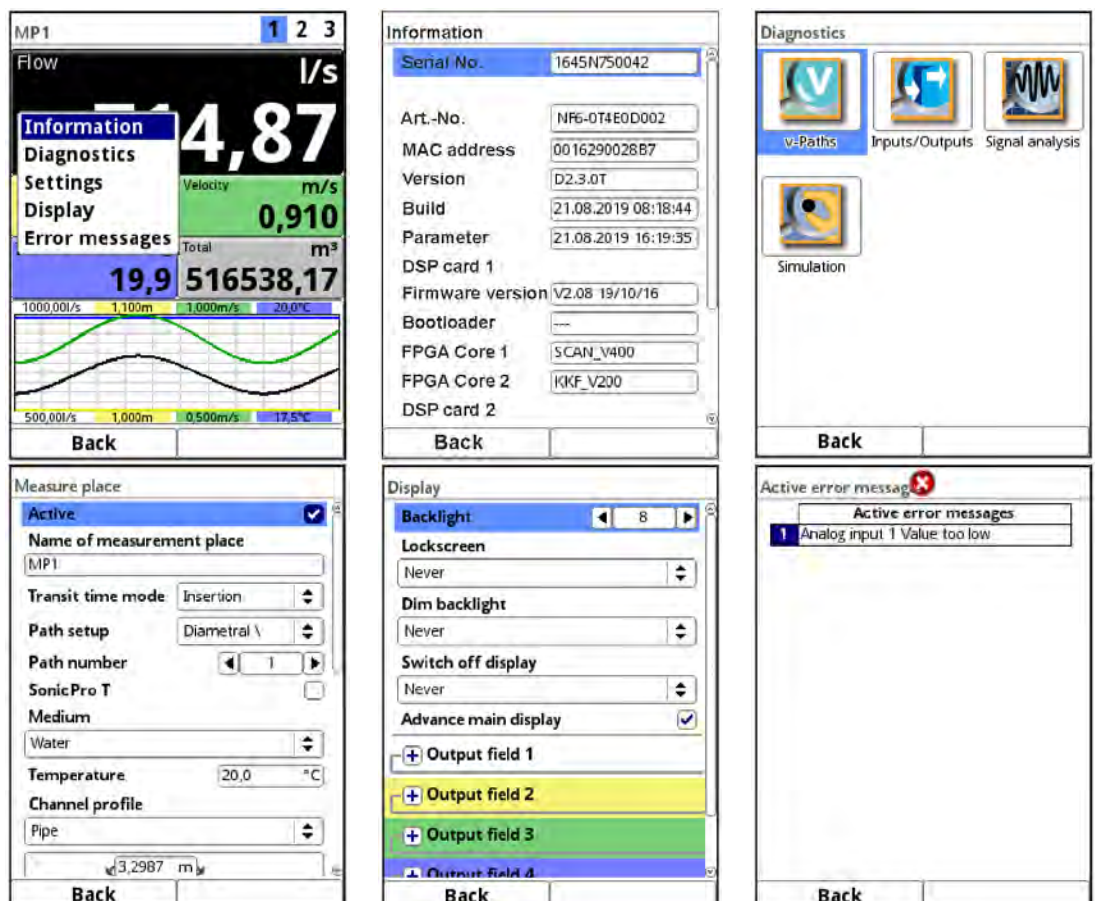

Fig. 31-3 Flow: Pop-Up-Menu and Menu Pages

31.2 Display Field Level of Measurement Places 1 and 2

After activating the dialogue window by pressing the rotary pushbutton, the menu Display can be accessed via the pop-up menu (see Chap. “38 Parameter Menu Display”).

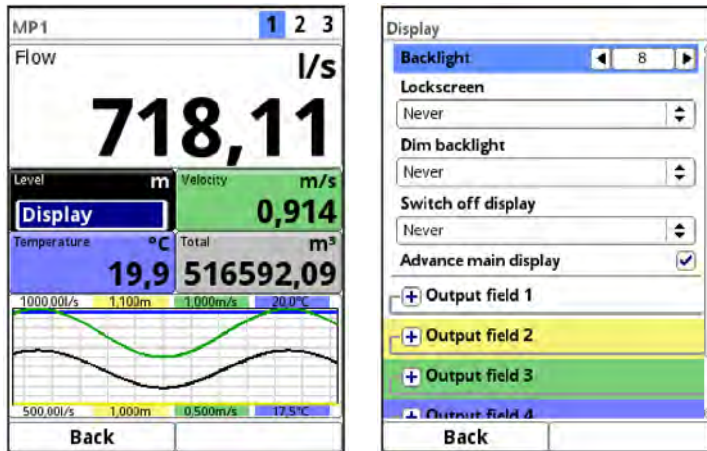

Fig. 31-4 Level: Pop-Up-Menu and Menu Page

31.3 Display Field Velocity of Measurement Places 1 and 2

After activating the dialogue window by pressing the rotary pushbutton, the individual menus (Diagnostics, Settings and Display) can be accessed via the pop-up menu (see Chap. “41 Diagnostics v-Paths”, “34.3 Setting Parameters in Menu v-Paths” and “38 Parameter Menu Display”).



Fig. 31-5 Velocity: Pop-Up-Menu and Menu Pages

31.4 Display Field Temperature of Measurement Places 1 and 2

After activating the dialogue window by pressing the rotary pushbutton, the menu Display can be accessed via the pop-up menu (see Chap. “38 Parameter Menu Display”).

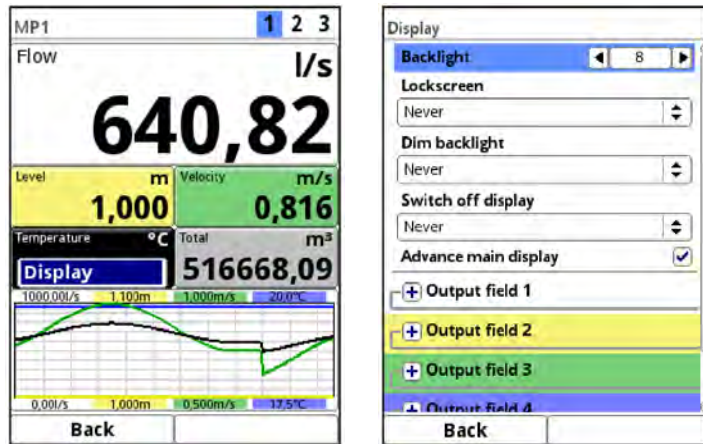

Fig. 31-6 Temperature: Pop-Up-Menu and Menu Page

31.5 Display Field Total of Measurement Places 1 and 2

After activating the dialogue window by pressing the rotary pushbutton, the individual menus (Total, Daily Totals and Display) can be accessed via the pop-up menu (see Chap. “35.2 Total”, “35.3 Day Totals” and “38 Parameter Menu Display”).

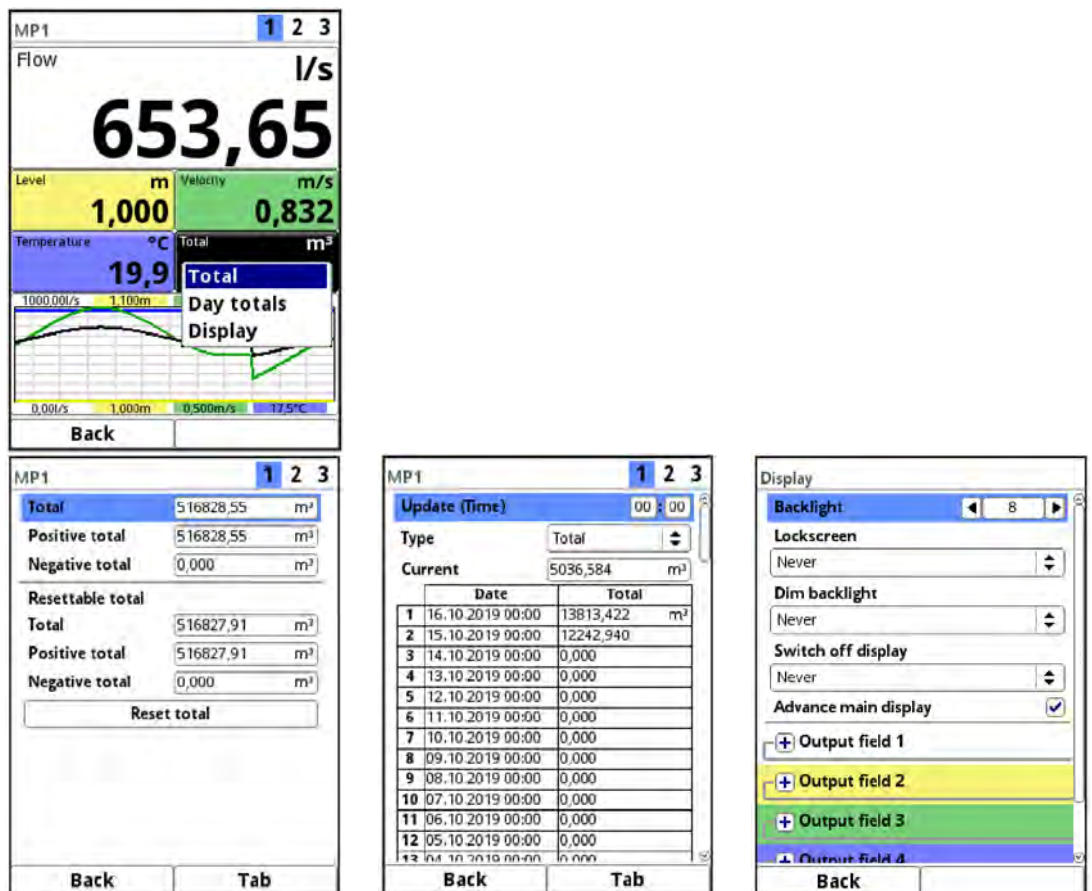

Fig. 31-7 Total: Pop-Up-Menu and Menu Pages

31.6 Display Field Trend/Hydrograph of Measurement Places 1 and 2

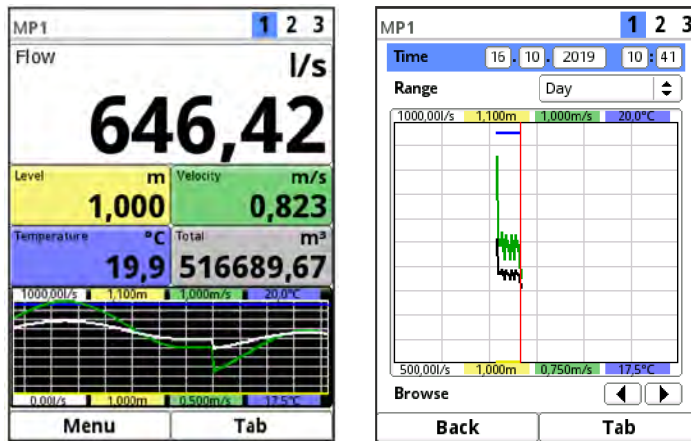

Fig. 31-8 Trend/Hydrograph: Pop-Up-Menu and Menu Page

If a more detailed and extensive graphic display is required beyond the main display, the graphic field can be selected directly.

The display period and the display area are available for selection.

The displayed time period can be moved using the >Scroll< function (arrow keys below the diagram).

31.7 Display Field Flow of the Combi Measurement Place

After activating the dialogue window by pressing the rotary pushbutton, the individual menus (Information, Diagnostics, Settings, Display and Error Messages) can be accessed via the pop-up menu (see Chap. “36.1 Information”, “Diagnostics”, “34.1 Setting the Parameters in the Measurement Place Menu”, “38 Parameter Menu Display” and “36.4 Error Messages”).

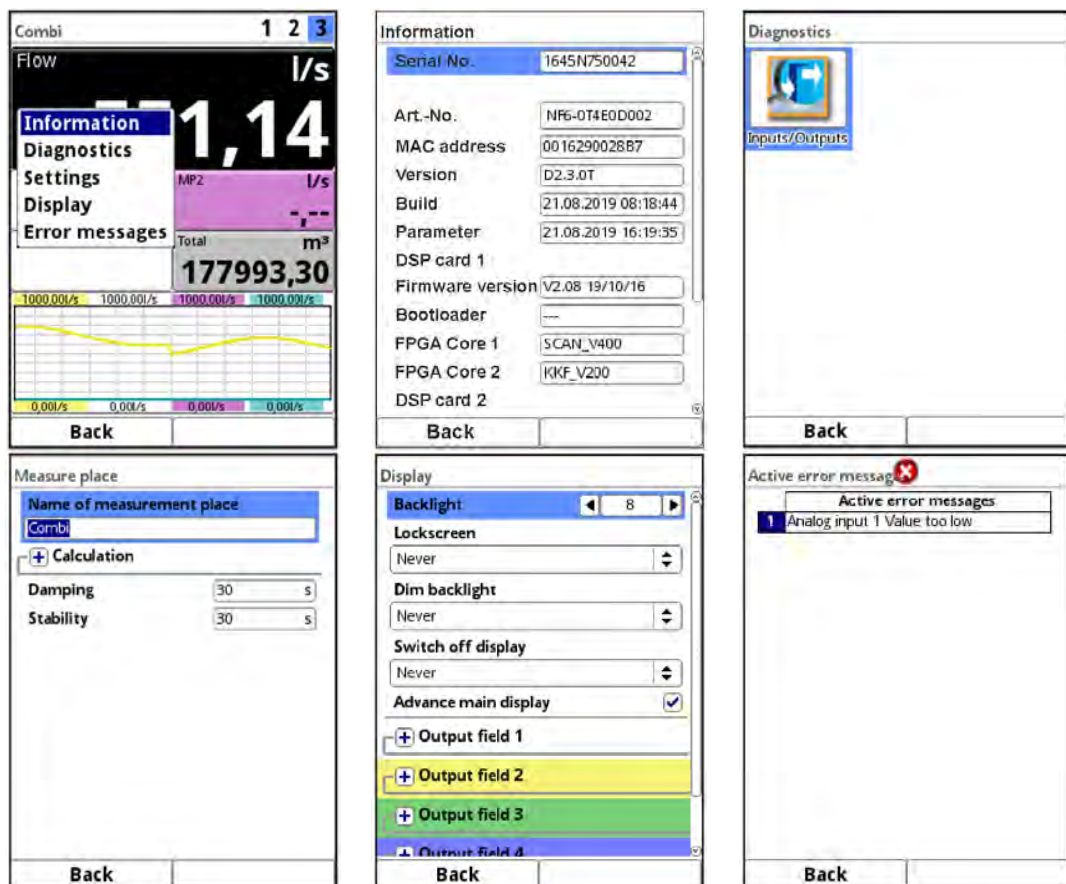

Fig. 31-9 Flow Combi: Pop-Up-Menu and Menu Pages

31.8 Display Field for Measurement Place 1/2 in the Combi Measurement Place

After activating the dialogue window by pressing the rotary pushbutton, the individual menus (Diagnostics, Settings, Display and Error Messages) can be accessed via the pop-up menu (see Chap. "Diagnostics", "34.1 Setting the Parameters in the Measurement Place Menu", "38 Parameter Menu Display", and "36.4 Error Messages").

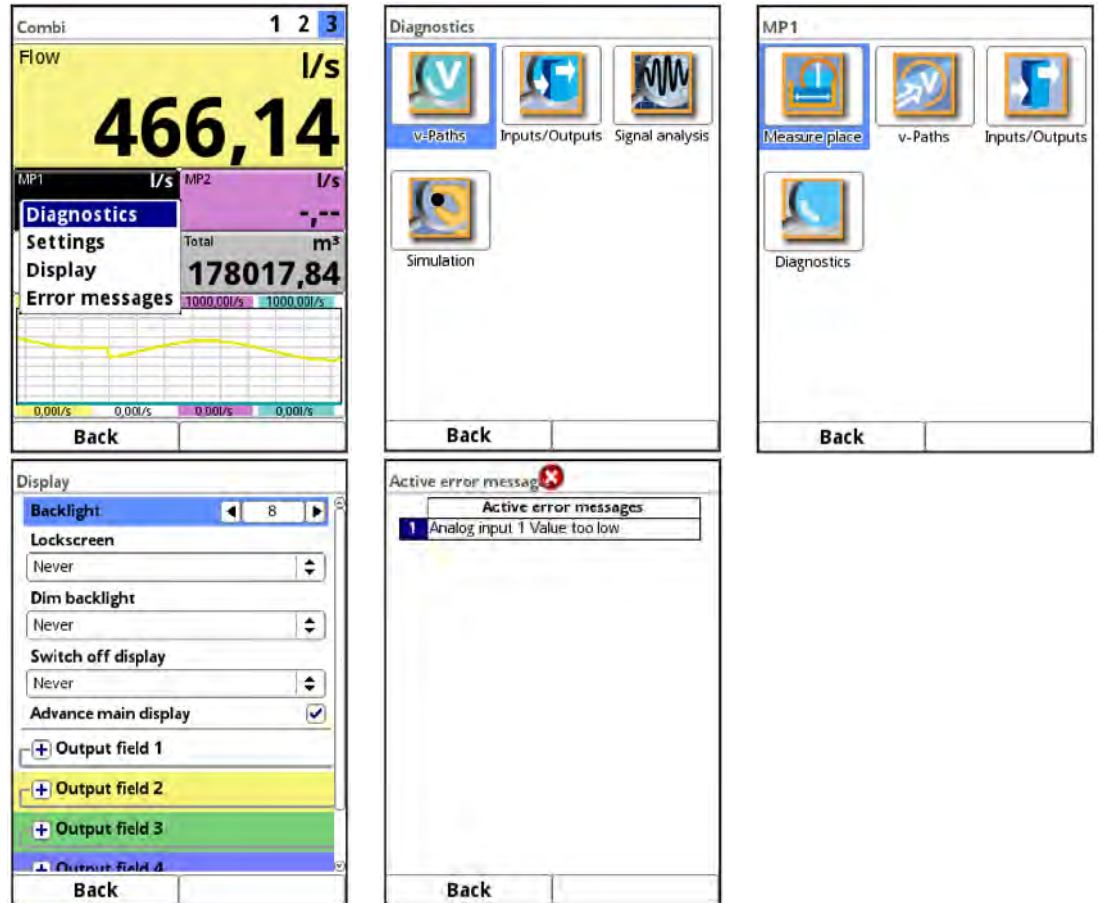

Fig. 31-10 MP1 Combi: Pop-Up-Menu and Menu Pages

31.9 Display Field Total of the Combi Measurement Place

After activating the dialogue window by pressing the rotary pushbutton, the individual menus (Total, Daily Totals and Display) can be accessed via the pop-up menu (see Chap. “35.2 Total”, “35.3 Day Totals” and “38 Parameter Menu Display”).



Fig. 31-11 Total Combi: Pop-Up-Menu and Menu Pages

Setting Parameters

32 Basics

In principle, changed parameters do not become effective before they have been saved. When leaving any menus, the transmitter checks whether parameters have been changed. Finally, you will be asked whether you wish to save the parameters.

- >Yes<: The changed parameter setting is accepted and saved.
- >No<: The changes to the parameters are discarded and the transmitter exits the menus.
- >Cancel<: You exit the query, remain in the parameterisation and can continue with the adjustment of the parameters. The changed parameters are not yet effective and not saved.

32.1 Save Parameters

Enter a valid password to accept and save the parameters.

Default setting: 2718

The **service key** in the upper display area indicates that the password has been entered within the last six hours and that all further **parameter changes** can be saved **without** having to enter the **password** again. The six-hour period begins when the password is entered once and ends automatically.

This period and thus the possibility to unintentionally change parameters without password entry can be deliberately cancelled. To do this, select the >Service Level< under >System< / >Service<. When asked for the password, do **not** make an entry, but confirm the empty, untouched field with the right button >Enter<. The transmitter exits the mode with parameterisation without password entry.

If a number is displayed directly next to the service key, the transmitter is in service mode. This is usually the case when a NIVUS service technician has access to the transmitter.

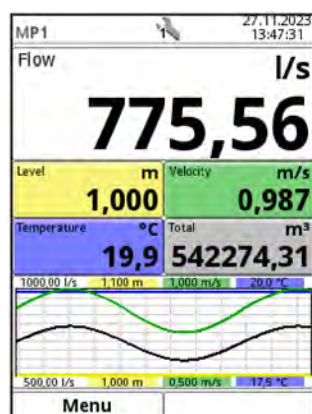

Fig. 32-1 Service Key - Service Mode

32.2 Change Password

➡ See also Chap. "36.5.2 Change (System) Password".

The default password can be changed at any time. Note that a changed password secures the changes to all transmitter settings. The input is limited to a maximum of ten characters.

➡ Procedure to change the password:

1. Open the >System< menu.
2. Select the >Service< submenu.
3. Activate the >Change Password< field.
4. Enter the existing password by using the numerical field.
5. Enter the new password (ten characters max).
The new password is accepted by the transmitter and saves all transmitter settings.



Important Notice

Only give the password to authorised persons!

If you write down the password, keep it in a safe place.

If the password is lost, contact the NIVUS hotline.

33 Parameter Functions

33.1 Main Menu

The transmitter is parameterised via the total of up to eight nine (depending on equipment) setting menus on the first menu level. The individual menus and submenus are explained in greater detail starting with Chap. "34 Parameter Menu Application / MP1 / MP2 / Combi".

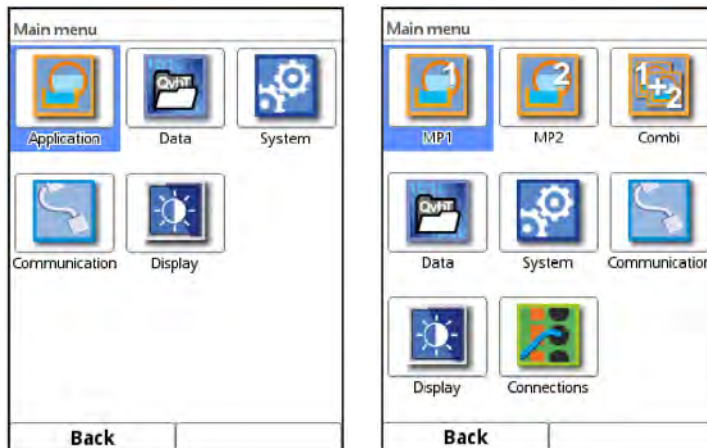

Fig. 33-1 Overview Main Menu

➡ When setting parameters observe Chap. "27 Principles of Operation".

33.2 Functions of the first Menu Level

33.2.1 Menu - Application / MP1 / MP2 / Combi

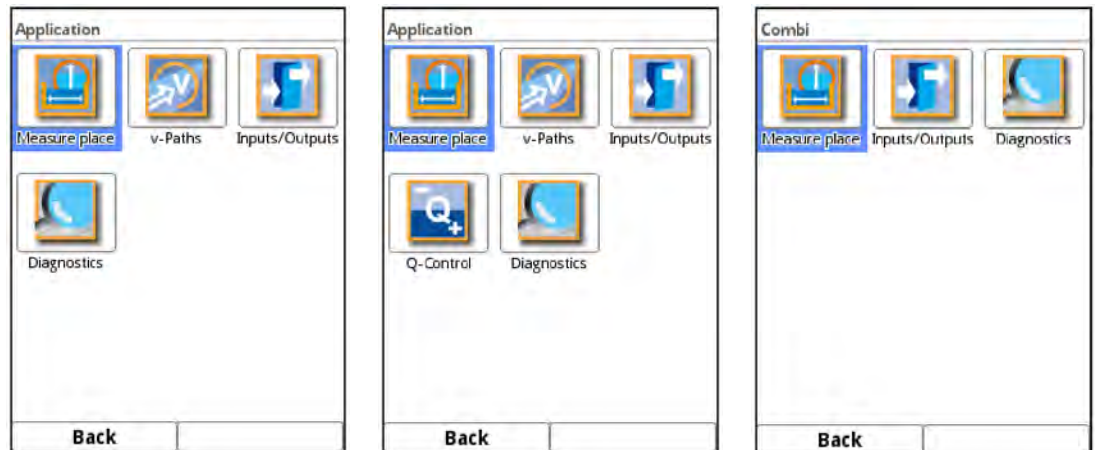

Fig. 33-2 Menu - Application

This menu is the most comprehensive and important within the parameterisation of the transmitter. The >Application< menu contains up to five submenus, depending on the device version/equipment. The shape and dimensions of the measurement place(s) are parameterised here. The flow velocity sensors used are defined and the data for their mounting position is parameterised.

You also define the required analogue and digital inputs and outputs here:

- Functions
- Measurement Ranges
- Measurement Spans
- Limit Values
- Error Messages
- Actuator Controls if required

The parameters of the flow controller (Q-Controller) are set under >Application<. The flow controller (Q-Controller) is available with NivuFlow 600 Types TR/GR/TZ/GZ.

In the >Application< menu there are diagnostic options available for:

- Sensors
- Inputs and outputs
- Overall system
- Signal analysis
- Simulation (of velocities and inputs and outputs to verify the function of the overall system)



The diagnostic functions are explained in Chapter "Diagnostics" starting on Page 154.

The following can be specified or changed in the >Application< menu:

- Constant, fixed sludge levels
- Low-flow suppression
- Damping of signal evaluation and output
- Stability of signal evaluation and output

The parameterisation for the combi measurement place differs from that for measurement places 1 and 2. The combi measurement place is a virtual measurement place whose data is generated from the measurement results of both measurement places 1 and 2.

➡ See Chap. "34 Parameter Menu Application / MP1 / MP2 / Combi".

33.2.2 Menu - Data

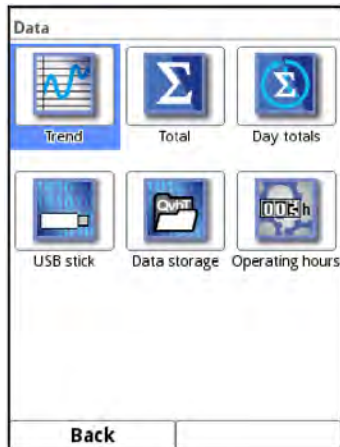

Fig. 33-3 Menu - Data

The >Data< menu allows access to all internally saved measurement values.

The following functions are available:

- Graphic representation of the measurement values
- Listing of the last 100 24h day totals and operating hours
- Listing of all totals (resettable and non-resettable positive, negative and grand totals)
- Communication and transmission options of internal files
- Loading and saving parameters
- Formatting the external USB stick
- Transfer of set parameters from and to USB stick
- Setting and deleting options of the internal data memory
- Setting the storage cycle

➡ See Chap. "35 Parameter Menu Data".

33.2.3 Menu - System

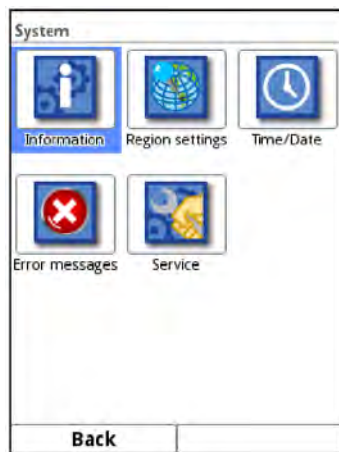

Fig. 33-4 Menu - System

The >System< menu contains information on the transmitter:

- Article Number
- Firmware version
- Serial number
- MAC Address
- Information about Open Source Software used in the device firmware (Credits/Licences)

In addition, the following settings/corrections are possible:

- Set Language
- Set units (for measurements or storage, unit system, decimal separator)
- Set/correct date and time (system time, time zone, time server)
- Read active messages
- Show/Delete error memory
- Change Password
- Restart (system or measurement)
- Parameter Reset
- Disable Coin Cell
- Update of transmitters and sensors (in service level; only in consultation with NIVUS)



See Chap. "36 Parameter Menu System".

33.2.4 Menu - Communication

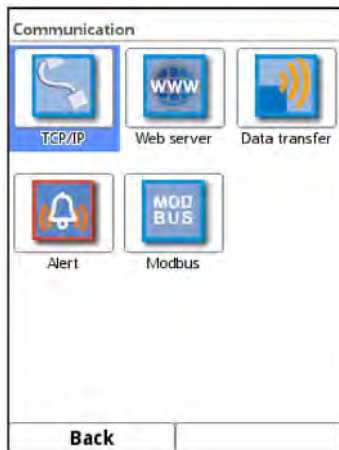

Fig. 33-5 Menu - Communication

This menu includes the setting options of various communication interfaces with other communication systems.

- TCP/IP
- Web Server
- Data Transmission
- Alarm (Message Alarm Settings)
- Modbus

⇒ See Chap. "37 Parameter Menu Communication".

33.2.5 Menu - Display

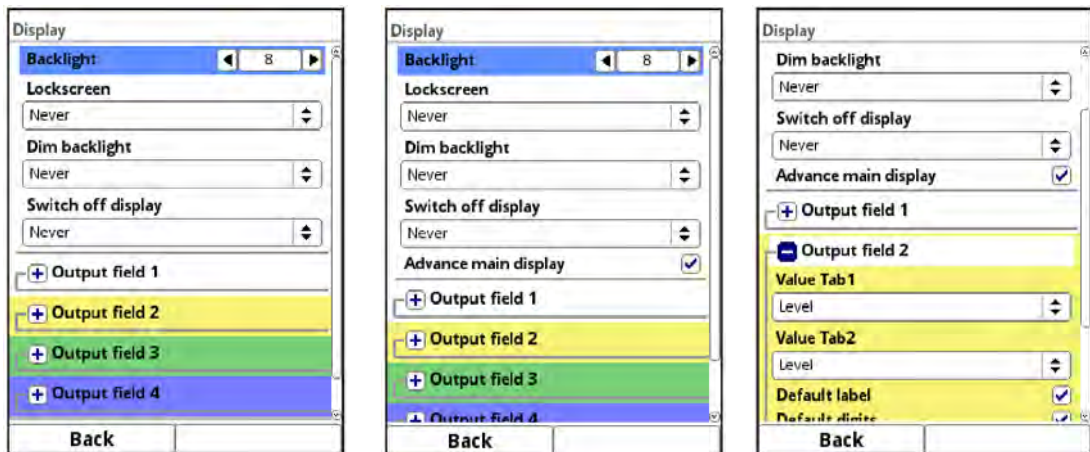

Fig. 33-6 Menu - Display

In this menu, adjustments are made to the background lighting, any corrections to the five output fields of the main display are set if necessary, and (de)activation of the main display (for multiple measuring points) is set.

⇒ See Chap. "38 Parameter Menu Display".

33.2.6 Menu - Connections



Fig. 33-7 Menu - Connections

This menu is only available with transmitters Type T4/G4/TM/GM as it is directly related to the transmitter's capability to handle multiple measurement places.

The two DSP cards (digital signal processor cards) and the analogue and digital inputs and outputs of the respective measurement places are assigned here. Only the measurement places assigned here can subsequently be parameterised and included in the calculations.

34 Parameter Menu Application / MP1 / MP2 / Combi

34.1 Setting the Parameters in the Measurement Place Menu

The submenu >Measurement Place< is one of the most important basic menus in the parameterisation.

The parameter settings of the measurement place include basic settings:

- Activating the measurement place (for types with multiple measurement places)
- Measurement Place Name
- Transit Time Mode
- Arrangement/Number of Paths
- Selecting the SonicPro T overvoltage protection
- Measurement Medium and Medium Temperature
- Type and dimensions of the channel profile
- Wall/pipe material and lining
- Possibly fixed settings for sediments
- 3D Preview
- Low-flow suppression
- Damping and stability of the measurement

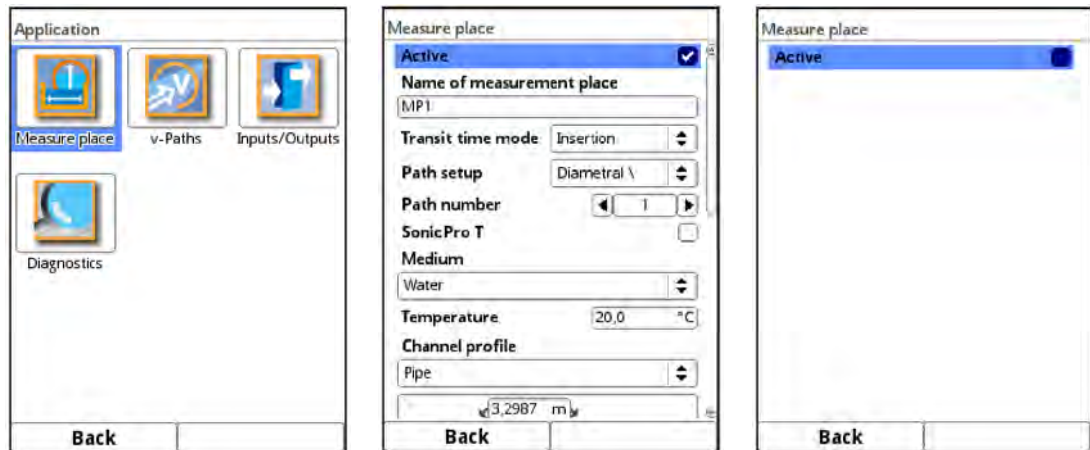

Fig. 34-1 Parameter Menu Application

34.1.1 Active/Activation of Measurement Places (only with multiple Measurement Places)

This option is only available with transmitters Type T4/G4/TM/GM as it is directly related to the transmitter's capability to handle multiple measurement places.

Checking the box activates the measurement place. If the box is not checked, the measuring point is inactive, nothing is displayed and its parameters cannot be set (Fig. 34-1).



Do not forget to assign the DSP cards

In addition to activating the measurement places, the DSP cards must be assigned accordingly in the >Connections< menu (DSP2 must be assigned to MP2).

See Chap. "39 Parameter Menu Connections".

34.1.2 Measurement Place Name



Fig. 34-2 Specifying the Name of the Measurement Place

The desired measurement place name is entered here. The input is limited to 256 characters. When resetting the measurement place name, the default name is automatically deleted after the first letter or number is selected.

Procedure:

1. Use the keypad to enter the measurement place name completely into the text field (see Chap. "27.3 Input via Keypad").
2. Confirm the measurement place name with the right function key "Input".

The measurement place name is transferred to the main menu and displayed there.

34.1.3 Transit Time Mode

Under >Transit Time Mode< the type of measurement method is set. The choices are:

- Clamp-On (sensors attached from the outside)
- Wetted (use of built-in sensors; in direct contact with the medium)

Depending on the selection, the view of the following menus changes. In this case, both variants are described at the appropriate place in the operating instructions.

Path Arrangement in Transit Time Mode >Clamp-On<

The clamp-on measurement is in the pipe (round) diametrically. The most common variants are the measurement in diagonal direction ("Diametral \") or the measurement as V-Echo ("Diametral V") (Fig. 34-3).

In the rectangle, the clamp-on measurement is chordal.

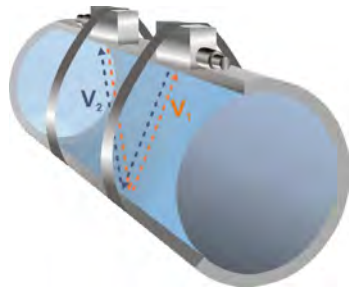

Fig. 34-3 1-Path measurement, path arrangement: "Diametral V"

The choices are:

- Diametral \ (only for "Pipe" channel profile, round)
- Diametral V (only for "Pipe" channel profile, round)
- Diametral VV (only for "Pipe" channel profile, round)
- Chordal \ (only for "Rectangle" channel profile)
- Chordal V (only for "Rectangle" channel profile)
- Chordal VV (only for "Rectangle" channel profile)
- Chordal X (only for "Rectangle" channel profile)
- Chordal XX (only for "Rectangle" channel profile)
- Chordal XXXX (only for "Rectangle" channel profile)

Path Arrangement in Transit Time Mode >Wetted<

Measurement with wetted sensors can be diametrical or chordal.

The choices are:

- Diametral \ (only for "Pipe" channel profile, round)
- Diametral V (only for "Pipe" channel profile, round)
- Diametral VV (only for "Pipe" channel profile, round)
- Chordal \
- Chordal V
- Chordal VV
- Chordal X

- Chordal XX
- Chordal XXXX

34.1.4 Number of Paths

A maximum of four paths can be connected directly. By connecting up to four extension modules, the number of paths can be increased to up to 32.

The number of paths is set by using the "+" and "-" fields, the number is displayed in the text field in between.

⇒ See also Chap. "34.3 Setting Parameters in Menu v-Paths".

34.1.5 SonicPro T

If a SonicPro T overvoltage protection element has been/is to be installed between the sensor and the transmitter or between the sensor and the NFE extension module, a check mark must be set here.

When wiring the sensors/system, the service technician must check in the >Application< / >Diagnosis< / >v-paths< menu whether he needs to connect a resistor to the overvoltage protection element and, if so, what colour it must be (blue or red).

⇒ See Chap. "Modifying "SonicPro T" Overvoltage Protection" starting on Page 62.

34.1.6 Medium

"Water" and "Custom" are stored for selection in the transmitter. "Water" is assigned fixed data; for "Custom", the number of entries and the respective sound velocities and information on damping and density of the medium must be entered.

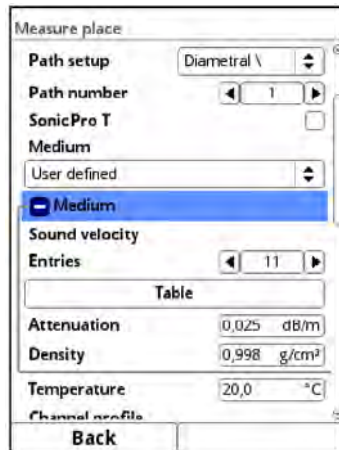

Fig. 34-4 Selection measurement medium



Selection measurement medium

If your medium to be measured is not in the selection, select "Custom".

In this case, another menu item opens in which you must enter, for example, the speed of sound of the medium.

Tip:

You can find lists of these sound velocities on the Internet or contact NIVUS GmbH.

34.1.7 (Medium) Temperature

The temperature of the medium must be entered once and as accurately as possible during commissioning and is required for the correct calculations of the transmitter.

34.1.8 Channel Profile

The choices are "Pipe" and "Rectangle". The "Pipe" is circular, not elliptical.

The selected profile is displayed graphically in the preview field. However, the entered dimensions (in proportion) do not match the graphical representation. There is no visual control.

☛ Select Profile.

After selecting the profile the dimension values are entered. The unit of measurement used is factory set in metres [m], but can be changed in the menu >System< / >Country Settings< / >Units< / >Level< (Fig. 34-5).



Fig. 34-5 Setting the measurement units

Entering the Canal Dimensions

For **pipe profiles**, two entries are sufficient for entering the pipe dimensions:

- Pipe circumference or inner diameter or outer diameter
- Wall thickness

After entering the inner diameter and wall thickness, the transmitter automatically adds the outer diameter and the pipe circumference. The same happens when circumference and wall thickness are entered. The transmitter complements the remaining parameters.

For **pipes with inner lining**, the thickness of the lining material must also be specified. The transmitter takes this material thickness into account and calculates the correct inner diameter.

For the **rectangular profile**, width, height and wall thickness are required. If there is a lining in the canal, the thickness of the lining must be specified too.

34.1.9 Wall material

Different pipe materials also have different properties in the speed of sound.

The most common pipe materials are stored in the selection menu.

Based on this selection and the specification of the measurement medium, the transmitter calculates the sound propagation time for the measurement.



Selection Wall Material

If the material of the pipe at the measuring point is not in the selection, select "Custom". In this case, another menu item opens in which you must enter, for example, the speed of sound of the pipe material.

Tip:

You can find lists of these sound velocities on the Internet or contact NIVUS GmbH.

34.1.10 Lining

In practice, it occasionally happens that pipelines have an inner lining. The most common lining materials are stored in the selection menu.

Based on this selection and the specification of the measurement medium, the transmitter calculates the sound propagation time for the measurement.



Selection Lining Material

If the material of the inner lining is not in the selection, select "Custom". In this case, another menu item opens in which you must enter, for example, the speed of sound of the pipe material.

Tip:

You can find lists of these sound velocities on the Internet or contact NIVUS GmbH.

34.1.11 Sludge Level

In horizontal pipe lines, depending on the measured medium, dirt load, grain size and flow velocity, deposits (sediments) may occur at the pipe bottom.

A fixed sediment height (deposit) in the pipe can be entered under sludge level. The entered sludge level is calculated as the "non-moving, bottom lying partial area of the channel with a horizontal surface". This height is subtracted from the total wetted hydraulic area before the flow calculation.

34.1.12 3D Preview

If the 3D preview is selected, the shape and dimensions of the parameterised measurement place with the respective sensors can be displayed with matching relations (depending on the accuracy of the parameter settings).

34.1.13 Low-flow suppression

This parameter is used to suppress the slightest movements or apparent quantities. The main field of application is the measurement of discharge rates in structures that are permanently dammed.

- ☑ Check >Active< and in the advanced menu enter the desired value for >Q suppressed< or >v suppressed<.



Fig. 34-6 Low-flow suppression

Low-flow suppression prevents the detection of the slightest changes in velocity. These changes can cause large apparent fluctuations in the measured volume over a longer period of time.

Flow velocities that are smaller than this parameterised value are "suppressed". This means that no quantity is recorded and the transmitter does not store a value.

- **>Q suppressed<**
Specify the flow value to be suppressed as positive value.
Negative values are not possible. The entered value is interpreted as an absolute value and has both a positive and negative effect. If the current, calculated measurement values are smaller than this parameterised value, the system automatically sets the measurement values to "0".
- **>v unterdrückt<**
Low-flow volumes can be suppressed here for applications in large profiles. The slightest changes in velocity can cause large apparent changes in volume over a longer period of time, which cannot be suppressed using the value >Q suppressed<. If the flow velocities are lower than this parameterised value, the system automatically sets the measurement values to "0".
This also makes the calculated volume "0".
Only a positive value can be specified. The entered value is interpreted as an absolute value and is effective for both positive and negative velocities.

34.1.14 Damping

This menu point allows you to change the damping of the display and analogue output in seconds.

The damping refers to all level and flow velocity values that are available as input values. Individual values cannot be selected and damped differently.

All measurement values are stored over the specified time range and a moving average is calculated for each individual measurement value. This average value is used for further calculation of the flow rate.

The time range is entered in steps of 1 second.

Default setting: 30 s

34.1.15 Stability

The stability is the time in which the transmitter bridges the values without correct measurement, i.e. in case of invalid flow velocity values. The transmitter operates during this period with the last valid measured value. If the specified time is exceeded without a correct value being recorded, the transmitter goes to the measured value "0", taking into account the set damping. The transmitter does not store a value.

The time range is entered in steps of 1 second.

Default setting: 30 s



Note on Stability

Extended stability makes the measurement insensitive to short-term disturbances.

34.2 Setting the Parameters in the Measurement Place Menu of the Combi Measurement Place

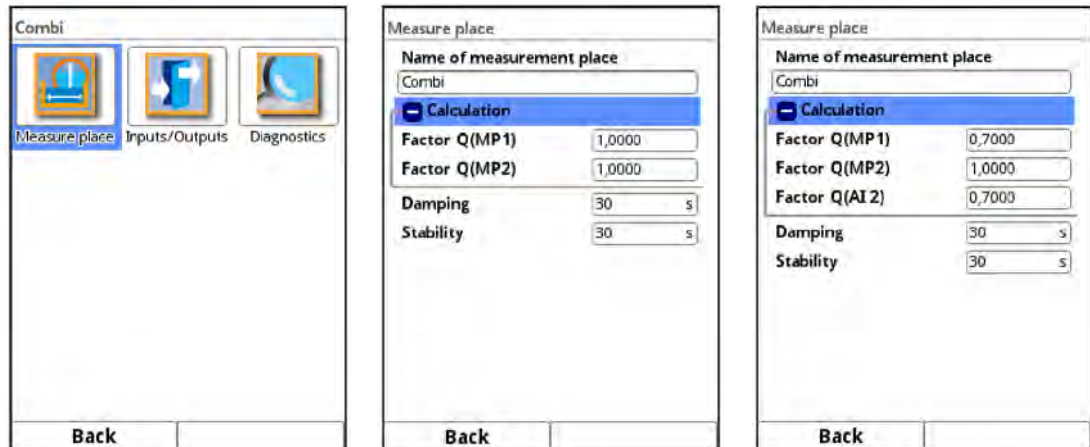

Fig. 34-7 Setting the Parameters of the Combi Measurement Place

For the virtual combi measurement place, the points **>Measurement Place Name<**, **>Damping<** and **>Stability<** are identical to those for measurement places 1 and 2.

➡ See Chap. "34.1.2 Measurement Place Name", "34.1.14 Damping" and "34.1.15 Stability".

In addition, the **>Calculation<** can be set. The adjustable values range from -100 to +100.
Default setting: 1,0000 for both measurement places

The individual totals of the measurement places are classified according to the parameterised factors Q in terms of how many percent they should be included into the total flow rate.

$$Q(\text{Combi}) = Q(\text{MP1}) \cdot \text{Factor } Q(\text{MP1}) + Q(\text{MP2}) \cdot \text{Factor } Q(\text{MP2}) + Q(\text{MP3}) \cdot \text{Factor } Q(\text{MP3})$$

The value 1 for **Factor Q(MPx)** means that the total of the respective measurement place is included in the calculation at 100 %.

If the value is less than 1, the corresponding measurement place is included with less than 100 % (0.9 with 90 %, 0.78 with 78 %, etc.), i.e. it is disproportionately lower included in the calculation.

A value greater than 1 then means a disproportionately higher influence on the total (higher than 100 %).

If the individual total of a measurement place is to be subtracted, prefix the factor with a "-" (-1).

➡ Procedure for **including inputs/outputs** (using the example of an analogue input) in the calculation of the combi measurement place (see Fig. 34-7 Fig. 3):

1. Assign analogue input to the combi measurement place under **>Main Menu< / >Connections< / >Analogue Inputs<**. (see Chap. "39 Parameter Menu Connections").
2. Assign the type "Flow" to the corresponding analogue input under **>Main Menu< / >Combi< / >Inputs/Outputs< / >Analogue Inputs<**.
3. Enter factor Q(AEx) analogue to the factors Q(MPx) of the measurement places: **>Main Menu< / >Combi< / >Measurement Place< / >Calculation< / "Factor Q(AE x)"**.

34.3 Setting Parameters in Menu v-Paths

Information in this menu item refers to the defined channel in terms of shape as well as spatial dimension (see "34.1.8 Channel Profile").

In this menu, you can also make some entries for the calculation of the sensor positioning. After the input, the transmitter shows the mounting distances of the sensors in this menu.

Depending on the type, up to **eight** flow velocity sensors (4 paths) can be connected **directly** to a NivuFlow 600 transmitter. **Indirectly** via one or more extension modules also up to **64** sensors (32 paths) (see Chap. "18.1 Device Versions").

In the >v-Paths< menu, the tabs with the v-paths 1 to x are displayed at the top right and can be parameterised one after the other (>Tab< button).

The basic structure is the same for all of them, but the sensors and values displayed can vary depending on the application.



Only a selection of v-paths can be parameterised

For transmitters with multiple measurement places, this menu works directly with the >Connections< menu. Only those v-paths that have been preselected under >Connections< can be parameterised. The other v-paths are not displayed and cannot be parameterised.



Recommended Sensor Arrangements and Installation Details

See "Mounting Instruction Transit Time Sensors".

34.3.1 Active

Checking the box activates the v-path. If the box is not checked, the v-path is inactive, nothing is displayed and its parameters cannot be set.

34.3.2 Cloning

Under Cloning, an already parameterised v-path can be selected in order to copy its parameters and transfer them to the current v-path. This can significantly simplify and speed up the parameterisation of multiple v-paths.



Fig. 34-8 Cloning

34.3.3 Sensor Types in Transit Time Mode >Clamp-On<

The same selection of sensors (Fig. 34-9) is available for all v-paths. You can select from >NIC0-K1L<, >NIC-CO01<, >NIC-CO50< and >Custom<.

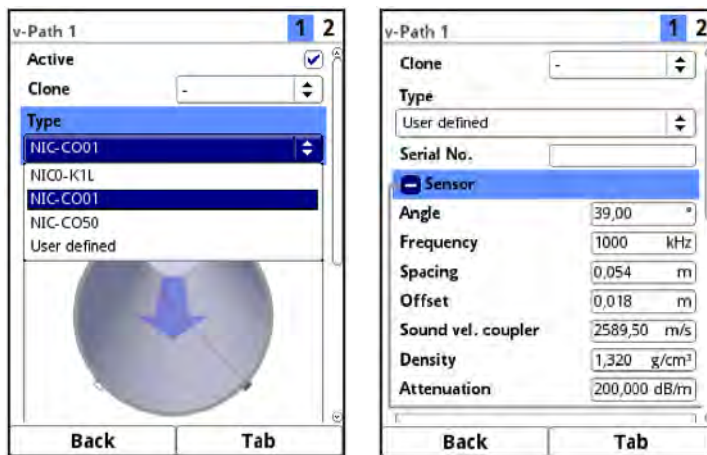

Fig. 34-9 Sensor Selection Menu

➤ Select the sensor type:

- >NIC0-K1L<, >NIC-CO01< and >NIC-CO50<
The values for the sensor itself are already predefined and cannot be selected or changed.
- >Custom<
The values for >Angle<, >Frequency<, >Spacing<, >Offset<, >Sound Velocity Coupling Wedge<, >Density< and >Damping< must be entered under "Sensor".



Expert knowledge required

The use and settings of/for special sensors require extensive specialist knowledge and NIVUS commissioning personnel or an authorised specialist company.

34.3.4 Sensor Types in Transit Time Mode >Wetted<

The same selection of sensors (Fig. 34-10) is available for all v-paths. You can select from the NIVUS transit time sensors and >Custom<.

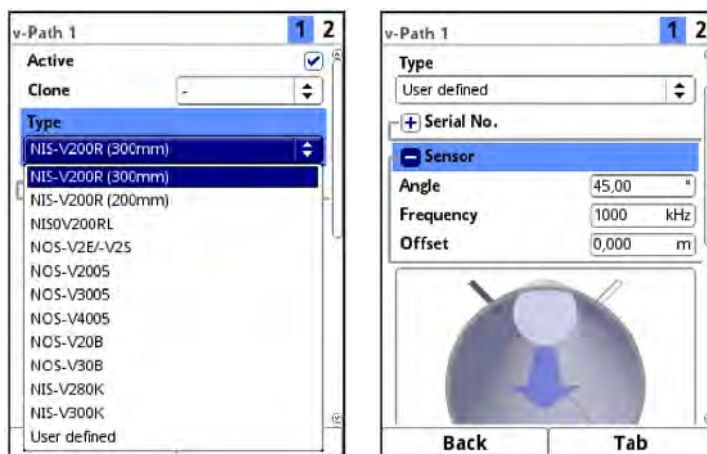

Fig. 34-10 Sensor Selection Menu

☞ Select the sensor type:

- >NIS-V200R (300mm)<, >NIS-V200R (200mm)<, >NIS0V200RL<, >NOS-V2E/-V2S<, >NOS-V2005<, >NOS-V3005<, >NOS-V4005<, >NOS-V20B<, >NOS-V30B<, >NIS-V280K< and >NIS-V300K<

The values for the sensors are already predefined and cannot be selected or changed.

- >Custom<

The values for >Angle<, >Frequency< and >Offset< must be entered.



Expert knowledge required

The use and settings of/for special sensors require extensive specialist knowledge and NIVUS commissioning personnel or an authorised specialist company.

34.3.5 Serial number

The serial numbers of the sensors used can be entered manually here. This provides a simpler overview and documentation of the application.

The sensors are combined into sensor pairs at the factory and matched to each other. They must therefore **always** be used together **as a pair**. The two sensors of the sensor pairs can have different serial numbers or the same one. This depends on the production date.

The serial number is entered using the keypad/number field.

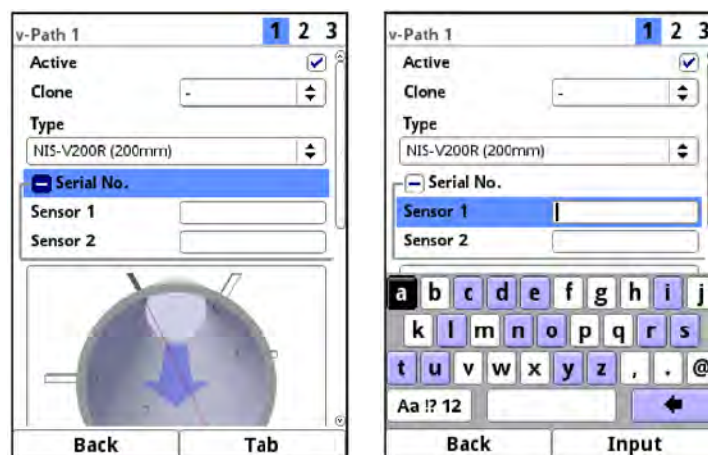

Fig. 34-11 Entering the sensor serial numbers

34.3.6 Installation/Mounting Position of Sensors



Note on the Mounting Angle

In horizontal pipelines, the top and bottom of the pipe should be avoided as installation locations (risk of sludge, air bubbles).

NIVUS recommend a mounting angle of 45°.

Note on Mounting Height

The transmitter suggests mounting heights based on the channel dimensions. These can be changed however.

- With >Transit Time Mode< "Clamp-On" and >Path Arrangement< / "Diametral" in >Channel Profile< "Pipe":
 - >Mounting Angle<
Clamp-on angle of the sensors in the pipe (in relation to the cross-section)

- With >Transit Time Mode< "**Clamp-On**" and >Path Arrangement< / "**Chordal**" in >Channel Profile< "**Rectangle**":
 - >Mounting Height<
Installation height of the sensors in the pipe (in relation to the cross-section)
 - >Mounting Angle<
Clamp-on angle of the sensors in the pipe (in relation to the cross-section)

Only one of the two specifications is required/possible for positioning the sensors. Changing the mounting height automatically changes the mounting angle and vice versa.

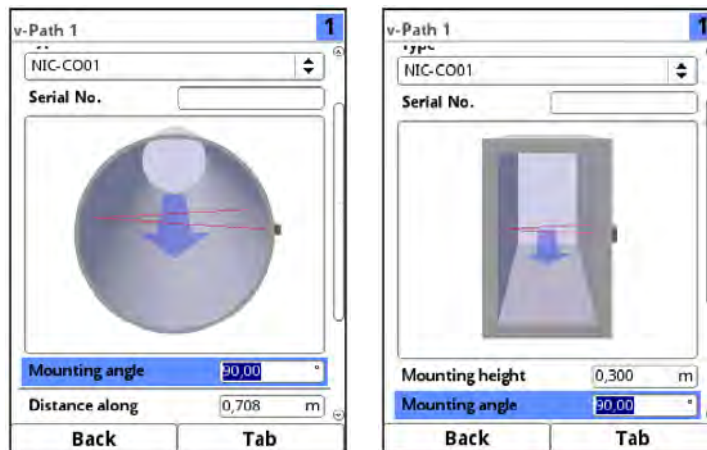

Fig. 34-12 Sensor mounting "Clamp-On" in pipe or rectangle

- With >Transit Time Mode< "**Wetted**" and >Path Arrangement< / "**Diametral **" in >Channel Profile< "**Pipe**":
 - >Mounting Angle<
Installation angle of the sensors in the pipe (in relation to the cross-section)
- With >Transit Time Mode< "**Wetted**" and >Path Arrangement< / "**Chordal **" in >Channel Profile< "**Pipe**":
 - >Mounting Height<
Installation height of the sensors in the pipe (in relation to the cross-section)
 - >Mounting Angle<
Installation angle of the sensors in the pipe (in relation to the cross-section)

Only one of the two specifications is required/possible for positioning the sensors. Changing the mounting height automatically changes the mounting angle and vice versa.
- With >Transit Time Mode< "**Wetted**" and >Path Arrangement< / "**Chordal **" in >Channel Profile< "**Rectangle**":
 - >Mounting Height<
Installation height of the sensors in the pipe (in relation to the cross-section)
 - >Direction<
The direction indicates which of the two sensors in the path is installed first or last in the flow direction (in relation to the cross-section)

Both details are required for positioning the sensors.

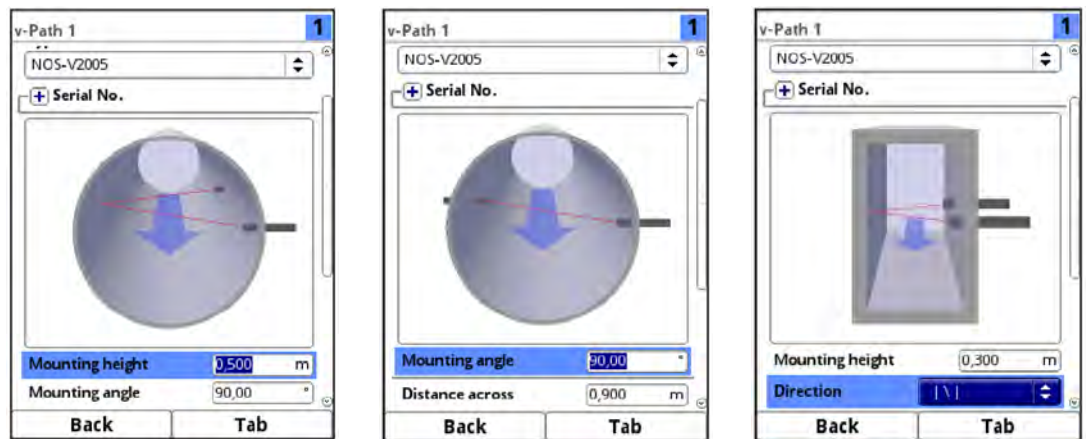

Fig. 34-13 Sensor mounting "Wetted" in pipe or rectangle

The following length and angle settings within a path are dependent on each other. Each change to an individual value leads to a change in the other values.

- **>Distance across<**
Distance from the sensor (centre of transducer) to the opposite inner pipe wall; adjustable only for wetted sensors
- **>Abstand along<**
Distance of the sensors (centre of transducer) in the longitudinal direction of the pipe; depending on the path arrangement also on the opposite side of the pipe
- **>Path Length<**
Length of the signal path within the medium
- **>Path Angle<**
Installation angle of the sensors to each other (within a path)

34.3.7 Mounting Support (only for NIS-V200R and NIS0V200RL)

The wetted pipe sensors NIS-V200R (300mm), NIS-V200R (200mm) and NIS0V200RL are mounted using special mounting supports. These must be selected during parameterisation. For the type **NIS0V200RL** this is a different mounting support (Fig. 34-14) than for the other two types.

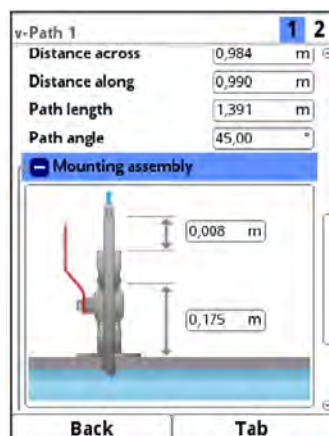

Fig. 34-14 Mounting support for sensor Type NIS0V200RL

For the types **NIS-V200R (300 mm)** and **NIS-V200R (200 mm)**, these are the mounting supports:

- Securing element (Fig. 34-15 Fig. 2) or
- Extraction Tool (Fig. 34-15 Fig. 3)

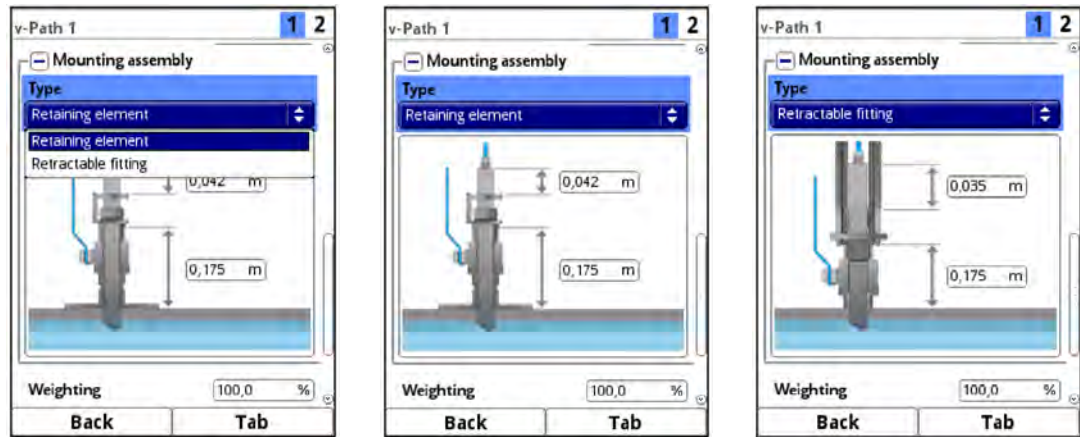

Fig. 34-15 Securing element and Extraction Tool for sensor Type NIS-V200R

The corresponding settings must be entered manually for all of them. Details can be clarified with the NIVUS customer service.

➡ See Chap. "47.2 Customer Service Information".

34.3.8 Weighting

When using several flow velocity sensor pairs, the valence of each individual flow velocity sensor pair to the measurement result of the average total velocity can be defined. The entry is made in the >Weighting< field.

Default setting: 100 (%)



Commission NIVUS or a different specialised company

The value of the weighting depends on the application and the sensor position.

Applications with multiple flow velocity sensor pairs require extensive knowledge of fluid mechanics and require the use of NIVUS commissioning personnel or an authorised specialist company.

The weighting is a dimensionless number between 0.0 and 100.0.

If only **one** v-sensor pair is used, entering a value other than "100" does not affect the results because the readings from the single sensor pair are always counted as 100 %.

When using **two or more** sensor pairs at one measuring point, the entered values for the weighting (= "Wght." in the following examples) of the individual flow velocity sensor pairs influence the total measured values output.

With **two** v-sensor pairs applies:

$$\text{Share of sensor pair 1} = \frac{\text{Wght. sensor pair 1}}{\text{Wght. sensor pair 1} + \text{Wght. sensor pair 2}} \cdot 100 \%$$

$$\text{Share of sensor pair 2} = \frac{\text{Wght. sensor pair 2}}{\text{Wght. sensor pair 1} + \text{Wght. sensor pair 2}} \cdot 100 \%$$

With **three** v-sensor pairs applies:

$$\text{Share of sensor pair 1} = \frac{\text{Wght. sensor pair 1}}{\text{Wght. sensor pair 1} + \text{Wght. sensor pair 2} + \text{Wght. sensor pair 3}} \cdot 100 \%$$

$$\text{Share of sensor pair 2} = \frac{\text{Wght. sensor pair 2}}{\text{Wght. sensor pair 1} + \text{Wght. sensor pair 2} + \text{Wght. sensor pair 3}} \cdot 100 \%$$

$$\text{Share of sensor pair 3} = \frac{\text{Wght. sensor pair 3}}{\text{Wght. sensor pair 1} + \text{Wght. sensor pair 2} + \text{Wght. sensor pair 3}} \cdot 100 \%$$

For **four and more** v-sensor pairs, the formula can be extended by the number of sensor pairs as desired.



Fig. 34-16 Weighting v-Sensor Pairs

34.3.9 v-Minimum and v-Maximum

The settings of >v-Minimum< and >v-Maximum< set the limit values for the velocity measurement. Individual higher and lower velocities are ignored by the transmitter and not displayed. If deviations are measured permanently, the transmitter displays them as "0" and only displays the next measurement results taken into account (within the defined measurement range).

Values from -10 to +10 m/s can be set.

Default setting:

- v-Minimum: -10 m/s
- v-Maximum: 10 m/s

34.3.10 v-Path Error

If the box is ticked, an error message is displayed if signal problems occur within the measurement path, e.g. signal is not sent/received.

34.3.11 Offset (Difference)

The adjustment value "Delta t" specified on the cables of the sensor pairs is entered here.

34.4 Setting Parameters in the Inputs and Outputs Menu (analogue and digital)

In this menu, the functions of the analogue and digital inputs and outputs are defined. Further parameter settings such as measurement and output spans, offsets, limit values, error reactions etc. are also possible in this menu.

➡ Open menu >Inputs/Outputs Inputs< via >Main Menu< / >Application<.

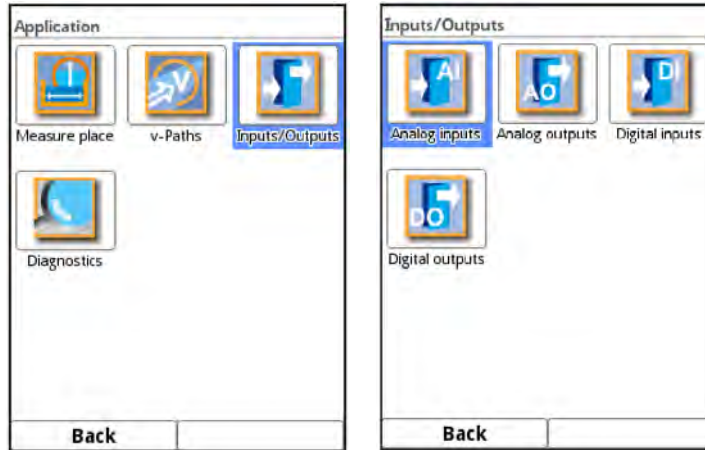

Fig. 34-17 Selecting Inputs and Outputs

The Inputs/Outputs menu is divided into four sections:

- Analogue Inputs
- Analogue Outputs
- Digital Inputs
- Digital Outputs



Note

Input via keypad: see Chap. "27.3 Input via Keypad".



Only a selection of inputs and outputs (analogue and digital) can be parameterised

For transmitters with multiple measurement places, this menu works directly with the >Connections< menu. Only those inputs/outputs that have been preselected under >Connections< can be parameterised. The other inputs/outputs are not displayed and cannot be parameterised.

34.4.1 Analogue Inputs

The number of analogue inputs depends on the device type (see Chap. "18.1 Device Versions").

The available analogue inputs are shown in the top right corner of the display.

Pressing the right control key >Tab< selects the analogue inputs one after the other. The selected input is shown in plain text in the top left corner of the display.

Default setting: Input inactive.



Fig. 34-18 Analogue Inputs: Activation / Ext. Reading / Flow Rate

The analogue inputs can be used as external measurement values (e.g. temperature in °C) or for flow measurement. The transmitter can hence be used as an additional data logger for measurement values from other systems. Its task as a flow transmitter is not affected by this.

The following different functions can be assigned to the analogue inputs.

- **External Measurement Value**
- **Flow**

The following settings for **input range**, **designation**, **linearisation**, **measurement delay** and **measurement duration** apply to all of the above functions.

- **Input range:** >0-20 mA< or >4-20 mA<
Designation: manual input
Linearisation: >2-Point< or >Table<
- For >2-Point< linearisation: manual input of the values for 4 of 20 mA
- For >Table< linearisation: enter the number of >Entries< manually, then select >Table<, fill in and confirm
Measurement delay: manual entry of values
Measurement duration: manual entry of values

34.4.2 Analogue Outputs

The number of analogue outputs depends on the device type (see Chap. "18.1 Device Versions").

The available analogue outputs are shown in the top right corner of the display.

Press the right-hand control key >Tab< to select the analogue outputs one after the other. The selected output is shown in plain text in the top left corner of the display.

Default setting: Output inactive

The following different functions can be assigned to the analogue outputs.

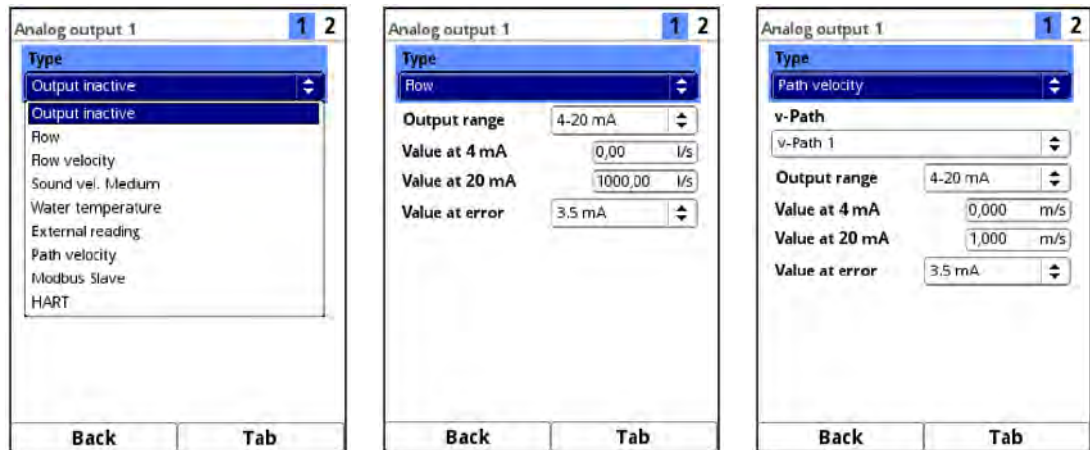

Fig. 34-19 Analogue Outputs: Activation / Flow / Path Velocity

- **Flow**
The flow rate of the application (calculated from average flow velocity and wetted cross-section) is output at the selected analogue output.
- **Flow Velocity**
The average calculated flow velocity (also calculated from two, three or more sensor pairs) used to calculate the current flow rate is available at the selected analogue output. Not possible for the combi measurement place.
- **Sound Velocity Medium**
The transmitter detects a change of medium by means of the calculated sound velocity. This e.g. allows for the automatic drainage of oil tanks.
- **Water Temperature**
The medium temperature detected by the flow velocity sensor can be output at the selected analogue output. Not possible for the combi measurement place.
- **External Reading**
Measurement values applied to the analogue input and linearised, if applicable, can be output here again.
The input used must first be selected in the settings.
- **Path Velocity**
If multiple flow velocity sensor pairs are used and the average flow velocity of the individual measuring paths is to be determined, the desired flow velocity sensor pair can be selected and its measured value output in analogue form (not possible for the combi measurement place).
The v-path used must first be selected in the settings.
- **Modbus Slave**
The value of the analogue output can be set by other systems via Modbus.
See also Chap. "1.1 Applicable Documentation": Technical Description NIVUS MODBUS.

The following settings of **Output Range**, **Output Span** and **Value at Error** apply to all functions explained above (except >Modbus Slave<).

- After selecting the function, the output range can be selected:
 - 0-20 mA
 - 4-20 mA
- Then enter the values for the output span.
- If the measurement value fails, an error behaviour can be set for the analogue output.

The following settings are possible in the event of an error:

- 0 mA
- Hold value (hold the last reading that is still valid (Hold))
- 3.5 mA
- 21 mA

34.4.3 Digital Inputs

The number of digital inputs depends on the device type (see Chap. "18.1 Device Versions").

The available digital inputs are shown in the top right corner of the display.

Pressing the right control key >Tab< selects the digital inputs one after the other. The selected input is shown in plain text in the top left corner of the display.

Default setting: Input inactive

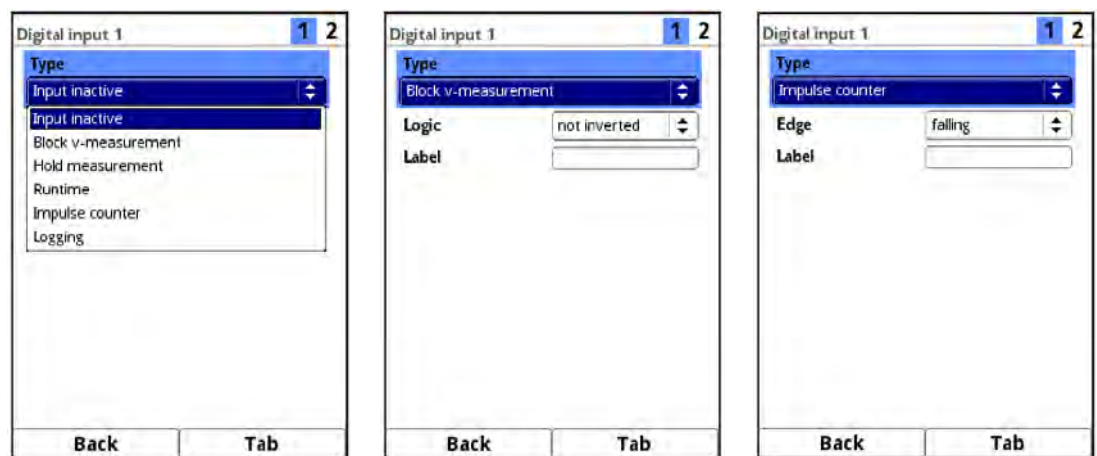

Fig. 34-20 Digital Inputs: Activation / Block v-Measurement / Impulse Counter

The following different functions can be assigned to the digital inputs.

- **Block v-Measurement** (NOT possible for the combi measurement place)
By means of an external contact the flow measurement can be blocked as long as a signal is present at the digital input.
- **Block summing** (ONLY possible for the combi measurement place)
Ticking the box deactivates the addition of the totals of measurement places 1 and 2. This means that only the two individual values for the flow rate are available.
- **Hold Measurement**
Activation of this digital input causes a "freezing" of the flow measurement value at the time of activation itself. Changing readings or values going to "0" no longer have any effect on the measurement value while the signal is applied to the input. The flow measurement value has an influence on a possible downstream process.

Application Example:

Maintenance/cleaning of the measuring section is carried out, which must be shut down for a short time for this purpose. However, the subsequent process (e.g. regulation with reference to the measured rate) should still continue.

- **Runtime**
The duration of the signal present at the digital input is recorded and stored by the system. This recording is used, for example, for pump or device running times.
- **Impulse Counter**
The number of the signals present at the digital input is counted and stored by the system. The evaluation of the counting impulse is done by detecting the change of

state of the digital input (1->0 or 0->1).

A minimum impulse duration of 100 ms is required for reliable detection.

- **Logging**

An applied signal is counted and stored including start and end time (time stamp function).

The possible applications are e.g. access control, event recordings, runtimes, etc.

The following settings of **Edge** or **Logic** and **Designation** apply to all functions explained above.

- **Edge:**
>rising< (change of state from "0" to "1") or
>falling< (change of state from "1" to "0")
- **Logic:** >not inverted< or >inverted<
- **Designation:** manual entry

34.4.4 Digital Outputs

The number of digital outputs depends on the device type (see Chap. "18.1 Device Versions").

The available digital outputs are shown in the top right corner of the display.

Pressing the right control key >Tab< selects the digital outputs one after the other. The selected output is shown in plain text in the top left corner of the display.

Default setting: Output inactive

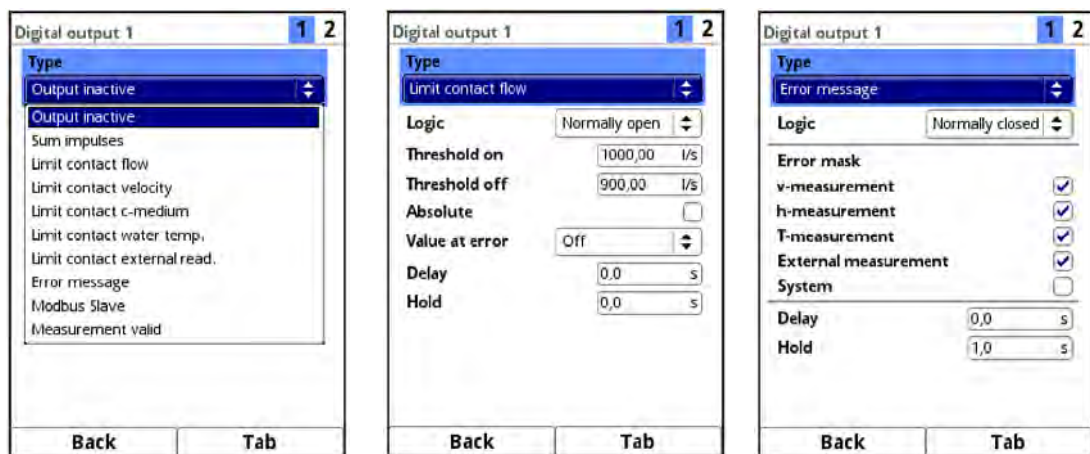

Fig. 34-21 Digital Outputs: Activation / Limit Contact Flow Rate / Error Message

The following different functions can be assigned to the digital outputs.

- **Sum Impulses**

Quantity-proportional sum impulses of the main sum counter ("Sum" in the main display) are output.

- Selection/input options:

Logic: >Normally open< or >Normally closed<

Negative sum impulses: check box

Quantity: manual input (impulses per quantity to define)

Duration: manual input (adjustable duration: 100...5,000 ms, the impulse/pause ratio is always 1:1)

- **Limit Contact Flow**

Set a flow limit value for >Threshold On< and >Threshold Off< respectively. If this flow limit is exceeded, a digital signal is output. If the flow falls below the second flow limit value, this digital signal is reset = hysteresis function to prevent fluttering outputs.

- Selection/input options:
Logic: >Normally open< or >Normally closed<
Threshold On: manual input
Threshold Off: manual input
Absolute: check
Value at error: >On< or >Off< or >Hold Value<
Delay: manual input (relay only switches when the conditions for the state to be output are present without interruption for at least this entered delay time and continue to be present at the time switch point)
Hold: manual input (prevent the digital output from reacting if the value briefly falls below a limit value)
- **Limit Contact Velocity** (not possible for combi measurement place)
 Here the digital signal is output when an adjustable velocity is exceeded.

 The average calculated flow velocity (also calculated from two, three or more paths) is used for this function.

 The settings and functionalities correspond to the procedure for >Limit Contact Flow< (see Page 108).
- **Limit Contact c-Medium**
 Here the digital signal is output when an adjustable sound velocity is exceeded.

 The settings and functionalities correspond to the procedure for >Limit Contact Flow< (see Page 108).
- **Limit Contact Water Temperature** (not possible for combi measurement place)
 Here the digital signal is output when an adjustable water temperature is exceeded.

 The settings and functionalities correspond to the procedure for >Limit Contact Flow< (see Page 108).
- **Limit Contact External Reading**
 The limit contact for an external measurement can only be used if at least one analogue input is set to "External Reading".

 The settings and functionalities correspond to the procedure for >Limit Contact Flow< (see Page 108).
- **Error Message**
 By activating the individual selection fields (check using the rotary pushbutton) the individual error types to be output can be assigned to the digital output. Furthermore, the output logic can be changed between normally closed and normally open function.
 - Selection/input options:
Logic: >Normally open< or >Normally closed<
Error mask:
v-Measurement: check box
h-Measurement: check box
T-Measurement: check box
External Reading: check box
System: check box
Delay: manual input
Hold: manual input



Digital output 2 cannot be selected as error output

Digital output 2 is not suitable as an error output since it is designed as a bistable relay. The relay remains in its last position in a de-energised state and cannot be used for error messages.

- **Modbus Slave**
The digital output can be used via the Modbus for the controlled output of a signal from other systems.
 - Selection/input options:
Logic: >Normally open< or >Normally closed<
- **Measurement valid** (only in conjunction with Cycle/Clock Control Mode)
The transmitter signals via this output that the measured values are valid for this measurement cycle.

This time period is particularly important when using externally connected data loggers so that they can access data values in cycle/clock control mode (see Chapter "35.5.2 Cycle Mode / Clock Control (function can be added via licence)").
 - Selection/input options:
Hold: manual input
- **Active** (only in conjunction with Cycle/Clock Control Mode)
As soon as the transmitter is active, this information is communicated to an externally connected data logger, which is then activated.
 - Selection/input options:
Logic: >Normally open< or >Normally closed<

34.5 Setting Parameters of the Flow Controller (Q-Controller) (function can be added via licence)

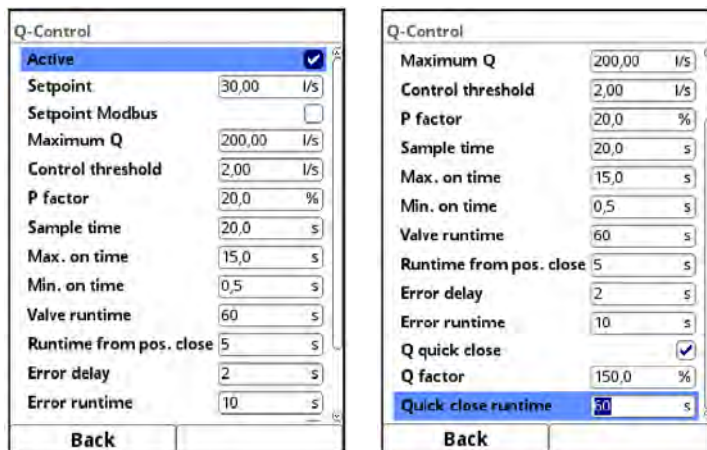

Fig. 34-22 Flow Controller (Q-Controller)

This menu is available for types TR/GR/TZ/GZ, provided they are equipped ex works with a 3-point step controller for controlling a slide valve or another actuator (equipment option, see Chap. "18 Equipment"). Furthermore, the functionality of the flow controller must be purchased via the additional function licence and this function licence must then be activated.

➡ See also Chap. "18.2 Add-On Function Licences" and "36.5.3 Feature Unlock".

To activate the flow controller in this menu, tick >Active<.

The flow controller is disabled **per default**.

The following values must be selected here or entered manually:

- **Setpoint**
This parameter defines the flow value to be controlled in the application. This is the internal setpoint of the unit. If an external setpoint is also used, parameterised via the associated analogue input, the internal setpoint becomes ineffective. Only in the event of an error (e.g. cable break of the external 4-20 mA setpoint) does the firmware use the additionally entered internal setpoint as a substitute.

- **Setpoint Modbus**
 This activation field is only visible if no external setpoint is used via the analogue input. In this case, the control setpoint is specified by the Modbus. If the Modbus does not provide a preset, the parameterised internal control setpoint is accessed.
- **Maximum Q**
 This parameter identifies the maximum occurring flow value at the measurement place. It is used to calculate the actuating time.
- **Control Threshold**
 The control threshold is also called control deviation in the control circuit area. This parameter defines the permissible control deviation of the control circuit without a control signal being output for the slider.
 Flow measurements tend to fluctuate slightly in practice for hydraulic reasons. If no setpoint deviation were allowed, the controller would constantly try to match the actual value exactly to the setpoint. This leads to constant actuator actuation and ultimately to increased wear and even defect of the slider.
Info:
In the area of sewer network management (stormwater treatment plants such as stormwater overflow tanks, stormwater retention basins, etc.), the DWA prescribes separation severities of 20 % for throttle discharge. For low-wear operation of the flow controller, this means a reasonable setting of the permissible control deviation of approx. 10...15 % of the setpoint.
- **P-Factor**
 The P-Factor (proportionality factor) indicates which actuating time effect a deviation Δw from the setpoint has.
 The greater the proportionality factor, the longer the actuating time of the slider with the same control deviation.
- **Sample Time**
 The sample time, also called cycle time, describes the processing interval of the flow controller. A short cycle time accelerates the control behaviour (faster reaching of the setpoint in case of a control deviation), but leads to oscillation of the control circuit after a certain point in case of longer running times of the medium (= idle time in the control circuit) between the actuator and the measuring point.
 A long cycle time reduces the tendency of the flow controller to oscillate, but at the same time increases the inertia of the control system.
 Practice-oriented value:

$$\text{Sample time} = \frac{\text{Average flow velocity}}{\text{Distance between actuator and measurement [m]}} \cdot 1.3$$

- **Max. On Time**
 The maximum control time for the actuator avoids overshooting of the controller function in the case of extremely large setpoint deviations and actuators with a short total slider runtime.
- **Min. On Time**
 The minimum control time (control impulse time) refers to the minimum running time of the actuator.
 If the actuating times are too short, they are added up until the minimum actuating time is exceeded so that the control impulses have such a long time that this actuation still causes a change in the actuator due to mechanical play.
 Practice-oriented value:

$$\text{Min. On Time} > \text{Relay switching time / switching contactor} + \text{Motor start-up time} + \text{Gear backlash} + \text{Slider play}$$

- **Valve Runtime**

The parameter is used to monitor spindle breakage, slider blade breakage, power failure of the servomotor, gear damage and other errors that manifest themselves in the fact that no further positioning movements are carried out despite control signals being present.

If the actuator does not reach the CLOSED limit switch after the specified total slider runtime, the system goes into error mode.

Practice-oriented value:

Slider runtime to be set = Time of the slider from OPEN to CLOSED position in continuous operation · 1.2...2.0 *)

*) smaller factor with longer slider runtime



The slider runtime has an influence on the calculation of the impulse time and must not be set to "0".

- **Runtime from Pos. CLOSED**

Defined time period until the zero position/error position is approached after a closing (CLOSED position).

- **Error Delay**

This parameter hides error messages that occur for a short time so that the system does not immediately go into error mode in the event of slightest disturbances. Specify the time in seconds.

- **Error Runtime**

Movement time of the slider in the "OPEN" direction in the event of an error.

A error occurs when the slider does not close due to stones or similar and the torque switch "CLOSED" is triggered before the switch "Way CLOSED".

Specify the time in seconds.

- **Q Quick Close**

This parameter activates the quick close function in the case of an event and enables the following two parameters: >Q-Factor< and >Quick Close Time<.

The quick close function is mainly used for large nominal diameters, long slider runtimes and long idle times. In the event of sudden rainfall events with torrential water volumes in large channels, it is used to move the control valve from the "OPEN" state to a time-defined, partially closed "CLOSED" state, irrespective of the calculated actuating time, thus preventing flooding. The closing takes place in continuous operation without interrupting the slider runtime.

- **Q-Factor**

Only visible with activated Q Quick Close.

If the control setpoint is abruptly exceeded by the set Q-Factor, the slider moves to the "CLOSED" state (in the time defined under Quick Close Time).

The setting is made in % and refers to the setpoint.

- **Quick Close Runtime**

Only visible with activated Q Quick Close.

When the quick close is triggered, the slider closes from the "OPEN" state in the defined time.

34.6 Setting Parameters in Menu Diagnostics

The diagnostics menu is required at the end of parameterisation or for troubleshooting during operation. Therefore, this menu is described after setting the parameters in Chapter "Diagnostics" starting at Page 154.

35 Parameter Menu Data

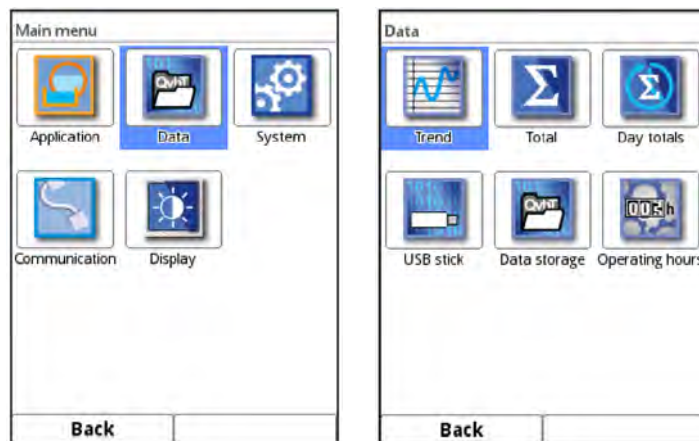

Fig. 35-1 Menu - Data

The data menu is primarily a display menu (recorder functions, totals, operating times, etc.). Furthermore, internally stored measurement values as well as the parameterisation of the measurement instrument can be loaded onto a USB stick (to be plugged in).

For the NivuFlow 600 Type with two or three measurement places, the tab key then displayed can be used to scroll between the individual active measurement places.

35.1 Trend

The trend display is a visualising recorder function. When the trend display is selected, the previously stored (historical) measurement data can be accessed.

The individual measurement places are shown at the top right of the display. Scrolling between the measurement places is possible via the Tab key.

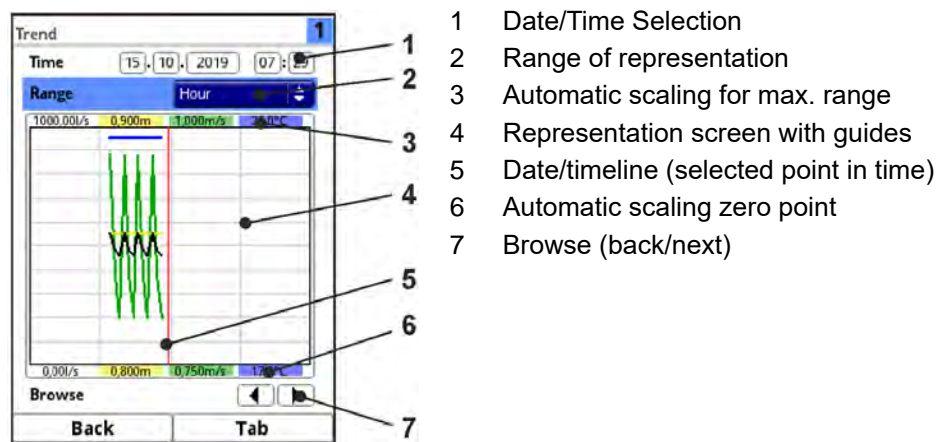

Fig. 35-2 Representation Trend Graph

➡ Procedure for the representation of current readings:

1. Select the desired range (range of representation; Fig. 35-2 Pos. 2).
The selected range (up to the current time) is displayed. During the display, there is no automatic updating of the measurement data (the current measurement data is shown in the lower third of the main screen).
2. If necessary, use the arrows (Fig. 35-2 Pos. 7) to scroll forwards and backwards with the same basic display setting.
3. Press the left function key ("Back") repeatedly to return to the main screen.

In the top area of the screen you can find the **Date/Time Selection** (Fig. 35-2 Pos. 1). The line is highlighted in blue and is therefore active.

➡ To select a specific point in time (historical measurement data), proceed as follows:

1. Press the rotary pushbutton - the first field (day) is activated.
2. Enter the desired day.
3. Press the rotary pushbutton again - jump to the next field (month).
4. Repeat the entry until the desired time is entered completely (day, month, year, hour, minute).
5. Confirm entry with the right function key. Date and time are adopted.
The display shows the measurement data of the selected date depending on the set time period (Fig. 35-2 Pos. 2).
The red vertical line (Fig. 35-2 Pos. 5) is on the selected point in time (date and time).

➡ To interrupt your input, press the left function key (Back).

Representation:

The selected period is shown from the left to the right edge of the display.

The **Time Period**, in which the data is to be displayed can be changed.

➡ This setting is made using the >Range< (see Fig. 35-2 Pos. 2).

1. Rotate the rotary pushbutton until >Range< is highlighted blue.
2. Press the rotary pushbutton - the selectable time periods become visible.

The choices are:

- (1) Hour
 - 4 Hours
 - (1) Day
 - (1) Week
 - 4 Weeks
3. Rotate the rotary pushbutton until the desired range is highlighted blue.
 4. Confirm entry with the right function key. The selected range is adopted.

Representation:

Selection	Representation in the Display Area		
	Left Margin	Right Margin	Guides
Hour	0 Minutes	59 Minutes	15 Minutes each
4 Hours	0/4/8/12/16/20 o'clock, depending on the set time	4 Hours later	1 Hour each
Day	0 o'clock	24 o'clock	4 Hours each
Week	Monday, 0 o'clock	Sunday, 24 o'clock	1 Day each
4 Weeks	Monday, 0 o'clock	4 Weeks later, Sunday, 24 o'clock	1 Week each, time reference point for the start: 29.12.1969, 0 o'clock

Tab. 9 Explanation of the periods displayed

**Note**

For the time period >4 Weeks< it may take a few seconds until the data is completely loaded.

Below the display you can find the **>Browse< function**.

- Browse forwards or backwards using the arrow symbols: by one selected period unit (Hour, 4 Hours, Day, Week or 4 Weeks) each time the button is pressed.

35.2 Total

The total sums, divided into positive and negative totals, are displayed for the respective measurement places. The total sum is the arithmetical sum of the positive and negative total.

Application Example:

Since commissioning, 10,000 cbm³ have flowed over the sensor coming from the front. In the same period, 2,000 cbm³ flowed back from the cable side of the sensor due to backwater.

The display now shows:

- Total 8,000 cbm³
- Positive total 10,000 cbm³
- Negative total 2,000 cbm³

The resettable totals are shown in the bottom area. Their meaning and operation is basically identical to the totals described in the upper section. The resettable totals can, if required, be set to "0" after reading after any period of time via the button **>Reset total<** and count up the totals again from this point on. This makes it easy to determine flow rates between two reading cycles. For security reasons, the reset must be confirmed by entering the password.

With the NivuFlow 600 with multiple measurement places, the individual measurement places are shown at the top right of the display. Scrolling between the measurement places is possible via the Tab key.

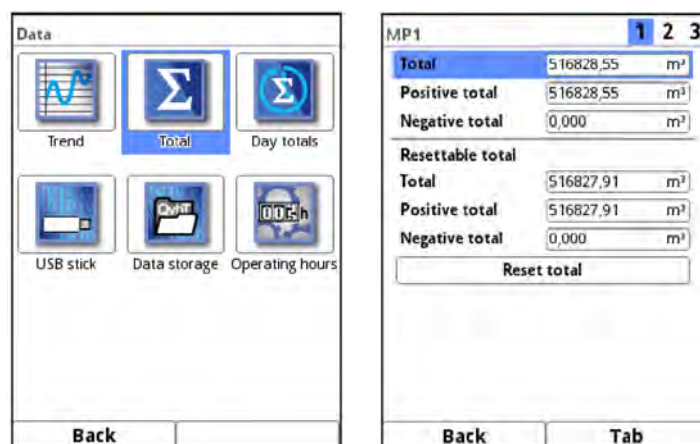

Fig. 35-3 Positive and Negative Totals

35.3 Day Totals

Here, the total flow values or also daily average values can be read in the displayed table. The values are 24-hour values in each case.

The entered update time shows the time at which the value formation takes place daily. This means that the entered value refers to the time range from 24 hours before this date/time to the set date/time.

As per **Default**, the values are always formed at 0.00 o'clock.

With the NivuFlow 600 with multiple measurement places, the individual measurement places are shown at the top right of the display. Scrolling between the measurement places is possible via the Tab key.

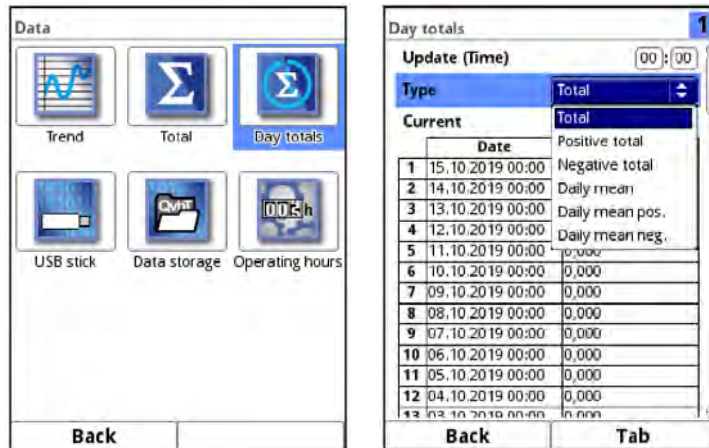

Fig. 35-4 Selecting Day Totals

The representation of the right table column can be changed by means of the setting **>Type<**. The following display setting options are possible:

- **Total:** total sums over 24 hrs each
- **Positive total:** positive totals over 24 hrs each
- **Negative total:** negative totals over 24 hrs each
- **Daily mean:** averaged value of the total sum over 24 hours each
- **Daily mean pos.:** averaged value of the positive total over 24 hours each
- **Daily mean neg.:** averaged value of the negative total over 24 hours each

Below the button for setting the type, the current daily value is displayed in **>Current<**. This reading will be moved to the first row of the table at the next update time (after 24 hours at the latest).

A maximum of 100 daily totals (= 100 days on which a value was recorded) are stored. From value 101 onwards, the oldest value is always overwritten (ring memory).

- ➡ Turn the rotary pushbutton to the right to scroll down in the table; to the left to scroll up again.

In this way, older daily values can also be displayed. A prerequisite for the display of older values is that the device has also been running for a longer period of time.

Example: 98 values - The device has been running for 98 days

Generally, only the daily values can be read on which the transmitter was actually in operation.

If the transmitter is switched off between two totalising events (< 24 hours), the transmitter calculates a total from the **measured** values. This total does **not** correspond to the **actual** daily quantity that flowed, but to the quantity that the transmitter measured while it was switched on.

When determining the daily average values, the "0" values during the switched-off period are included in the calculation.

Example:

There is a constant flow rate of 1,000 m³/h. If the transmitter was switched off between 08:00 and 10:00 o'clock, then it measures nothing for two hours. In that case, a total flow rate of 22,000 m³ is displayed at the end of the day. However, 24,000 m³ actually flowed. The transmitter has stored a flow rate of 0 m³ for the duration of these two hours and added it as a valid value to the total flow rate. The daily total does not show that the transmitter did not measure for two hours on this day.

If the transmitter is switched off before the time of the next totalising and then remains

switched off until the time of the next totalising (> 24 hours), the transmitter does not calculate a total or an average value for this period of time (see Fig. 35-5). No data is stored and the time period remains unknown. This "gap" can be recognised by the fact that the relevant entry (date/values) is completely missing in the list sequence. No blank lines are shown.

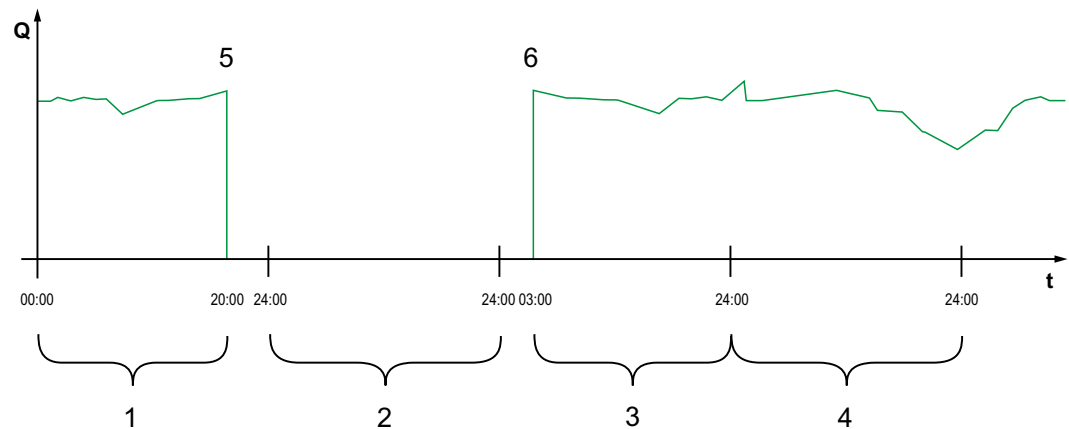

- 1 Total Day 1: total of 20 hours
- 2 Day 2: power failure - no totalising
- 3 Total Day 3: total of 21 hours
- 4 Total Day 4: total of 24 hours
- 5 Power failure
- 6 Power back again

Fig. 35-5 Scheme of Totalising

- The **time** of the totalising is 00:00 o'clock **by default**, but can be changed as described below.
- The factory setting of the time results in the **time period** of the totalising or averaging between 00:00 and 24:00 o'clock. This means that the daily total is always computed between 00:00 and 24:00 o'clock.

➡ Changing the time of totalising is done as follows:

1. Rotate the rotary pushbutton until >Update (Time)< is highlighted blue.
2. Press the rotary pushbutton - the hour section is activated.
3. Enter the desired start time for the totalising (e.g. 08:00) and turn to the minute section.
4. Specify the minute value.
5. Confirm the values with the right >Enter< function key.
The time of totalising is changed to 08:00 o'clock.
This automatically calculates the 24-hour value from 08:00 o'clock to 08:00 the next day.

The >Current< display field shows the subtotal that has accumulated since the last totalisation.

35.4 USB Stick

Requirements for the USB stick used:

- Formatted as FAT 32 (or FAT 12 or FAT 16) (the transmitter cannot read NTFS or exFAT)
- Maximum permissible memory size 32 GB (alternatively a larger USB stick that has been "force-formatted" to FAT 32)
- Partitioning table: MBR (GPT currently not supported)

Working with the USB Stick:

- ➡ Plug the USB stick into the slot above the display.

Function:

- Transmission of measurement data to USB stick
- Backing up device parameters to the USB stick
- Retransfer of saved parameters from the USB stick to the device
- Formatting the USB stick

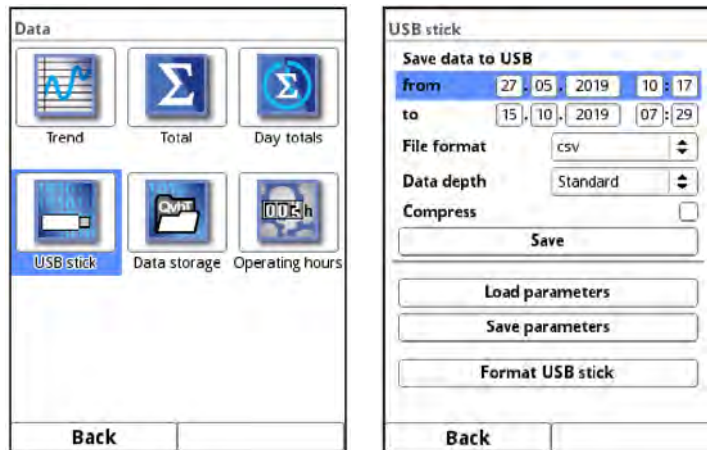

Fig. 35-6 Selection Submenu

The transmitter has an internal data memory. If required, part of the measurement data or all stored measurement data can be transferred to a USB stick.

Per default, the transmitter offers the transmission period since the last data transmission up to the current time. This transmission period can be adjusted, however.

- ➡ To **save data** to USB stick proceed as follows:

1. Press the rotary pushbutton - the first field is activated.
2. Turn the rotary pushbutton to select the day of the desired start time.
3. Press the rotary pushbutton again - now the month can be specified.
4. Repeat the process until the desired date and time have been entered completely.
5. Confirm the start time with the right >Enter< function key.
6. Turn the rotary pushbutton - the field >to< is highlighted blue.
7. Turn the rotary pushbutton to select the day of the desired end time.
8. Set the end time in the same way as the start time.
This sets the time period for the data to be transferred to the USB stick.

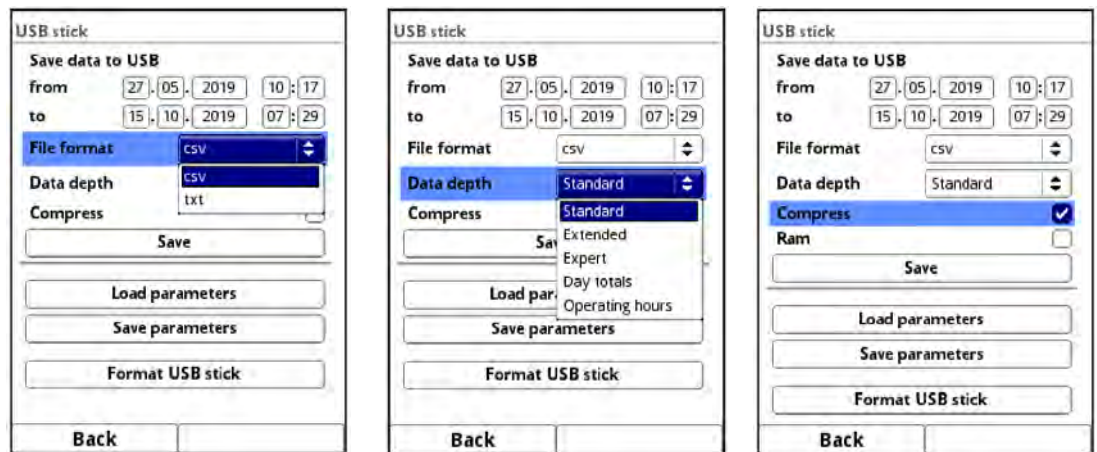

Fig. 35-7 Data Format / Data Depth / Compression

9. To select the desired file format, press the rotary pushbutton - a selection menu opens.
The choices are: txt and csv.
10. Press the rotary pushbutton to accept the file format.

The adjustable **data depth** comprises five possible selection ranges:

- **Standard**
This memory format is sufficient for most applications and corresponds with the default setting.
The stored records contain the following information:
 - Date and Time
 - Totaliser
 - Calculated Flow Rate
 - Average flow velocity
 - Water Temperature
 - Wetted cross-section
 - Current values and the values calculated from them for the activated analogue and digital inputs
- **Extended**
This data set is useful for controlling critical important applications and is mainly needed by service personnel.
The stored records contain the following information:
 - All data sets from the previous data depth >Standard<
 - Average flow velocities of individual v-paths
- **Expert**
This data set is useful for controlling critical important applications and is mainly needed by service personnel.
The stored records contain the following information:
 - All data sets from the previous data depth >Extended<
 - Noise
 - Amplification

- **Day Totals**

The totals saved in the menu >Data< / >Day Totals< as well as the positive and negative totals are stored on the plugged USB stick after selecting and pressing the button >Save<.

- **Operating Hours**

The operating hours per day saved in the menu >Data< / >Operating Hours< are stored on the plugged USB stick after selecting and pressing the button >Save<.

The **>Compress< function** is only useful for transmitting large amounts of data. In this case, the selected files are zipped into the ".zip" format. If this option is checked, **>Ram<** can also be selected and the data is written to the internal Ram memory (approx. 16 MB) instead of a USB stick. The selected, stored data can then be retrieved from this ram memory, e.g. via remote access.

☛ Once the transfer period, data format and data depth have been defined, save the data to the USB stick.

1. Activate the **>Save<** field.
2. Press the rotary pushbutton to save the data to the USB stick.

The generated table can contain the following data or information about the data, depending on the data depth set. The units in [] correspond to the default setting, but can be changed if necessary.



Note

The following table contains only the most relevant information. Different content can be displayed depending on the device type and parameterisation.

Unclear or special contents can be requested from the NIVUS customer service (see Chap. "47.2 Customer Service Information").

Name	Data Depth	Meaning
Date	Standard, Extended, Expert	Date of the table entry (time of storage)
Time	Standard, Extended, Expert	Time of the table entry (time of storage)
app1_sum [m³]	Standard, Extended, Expert	Positive flow rate total at the time of storage
app1_q [m³/s]	Standard, Extended, Expert	Flow volume at the time of storage, value calculated by the measurement system
app1_h [m]	Standard, Extended, Expert	Filling level at the time of storage, value used by the measurement system
app1_a [m²]	Standard, Extended, Expert	Calculated, hydraulically wetted area at the time of storage

app1_v [m/s]	Standard, Extended, Expert	Average velocity at the time of storage, value used by the measurement system
app1_t_water [°C]	Standard, Extended, Expert	Water temperature at the time of storage
app1_c_med [m/s]	Extended, Expert	Speed of sound of the medium, value calculated by the measurement system
p<x>_v [m/s]	Extended, Expert	Average velocity of the medium in the measurement path p<x> (x is placeholder for the path number: p1, p2, etc.)
p<x>_g_srch [dB]	Extended, Expert	Signal amplification of the search scan in the measurement path <x> (x is placeholder for the path number: p1, p2, etc.)
p<x>_g_sig [dB]	Extended, Expert	Signal amplification of the measurement signal in the measurement path p<x> (x is placeholder for the path number: p1, p2, etc.)
p<x>_ntyp_up [dBμ]	Extended, Expert	Typical noise on channel x against the direction of flow / upstream in the measurement path p<x> (x is placeholder for the path number: p1, p2, etc.)
p<x>_nmax_up [dBμ]	Extended, Expert	Maximum noise on channel x against the direction of flow / upstream in the measurement path p<x> (x is placeholder for the path number: p1, p2, etc.)
p<x>_ntyp_dn [dBμ]	Extended, Expert	Typical noise on channel x in the direction of flow / downstream in the measurement path p<x> (x is placeholder for the path number: p1, p2, etc.)
p<x>_nmax_dn [dBμ]	Extended, Expert	Maximum noise on channel x in the direction of flow / downstream in the measurement path p<x> (x is placeholder for the path number: p1, p2, etc.)
p<x>_tq [%]	Extended, Expert	Trigger quality in the measurement path <x> (x is placeholder for the path number: p1, p2, etc.)
sys_t [°C]	Expert	Temperature within the transmitter

Tab. 10 Information on the Data (USB Storage)

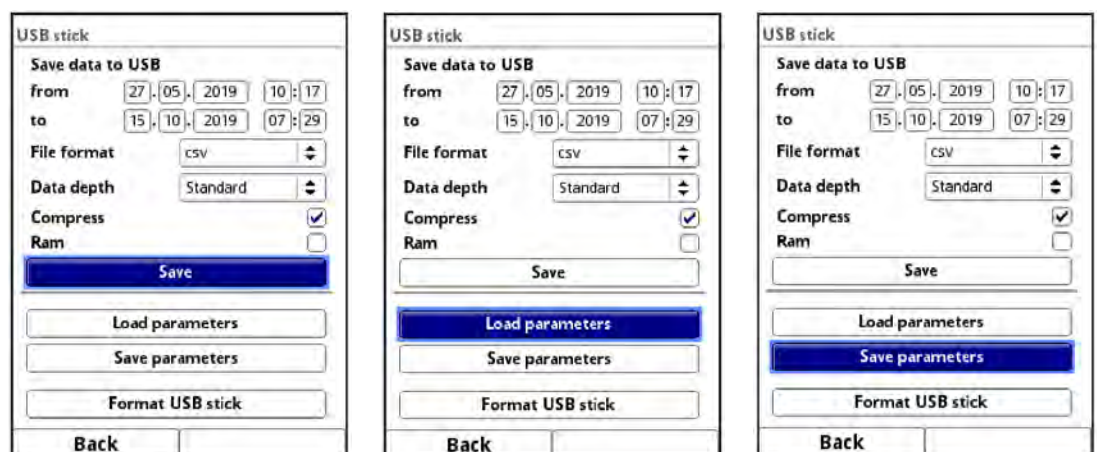

Fig. 35-8 Save / Load Parameters / Save Parameters

With the function **>Load Parameters<** a previously saved parameter file can be loaded from the USB stick to the transmitter.

With the function **>Save Parameters<** the set parameterisation of the measurement place can be loaded to the USB stick. Here two files are created and saved.

The files have the following formats:

- **XXXX_DOC_AABBCCDDEE.pdf**
This file is for documentation purposes and can be opened and printed directly using a pdf reader. In the header, it contains information on the transmitter type, date and time of parameterisation, firmware, serial number and article number of the transmitter. Basic parameter settings such as measurement place description/dimensions, used and parameterised sensors in relation to type, installation position, installation height, installation angle etc. are output. In addition, the display of the parameter settings of analogue and digital inputs and outputs, a possibly parameterised flow controller incl. its parameters, various system information such as time/date format, country and device settings as well as Modbus and display settings.
- **XXXX_PAR_AABBCCDDEE.xml**
This file contains the complete parameter set of the transmitter. It is used to save the parameterisation that has been set and can only be read by the device due to the file format.

Information on File Naming:

XXXX	=	Name of the measurement place set
AA	=	Year
BB	=	Month
CC	=	Day
DD	=	Hour
EE	=	Minute

➡ Unformatted or incorrectly formatted USB sticks can be converted to the correct storage format directly at the device:

1. Rotate the rotary pushbutton until **>Format USB Stick<** is highlighted blue.
2. Press the rotary pushbutton - the plugged USB stick is formatted.
When the USB stick has been formatted, the message **>SUCCESSFUL<** appears on the display.

35.5 Data Memory (Internal)

35.5.1 Basic Functions

In this submenu you can change the storage cycle and delete the internal data memory.

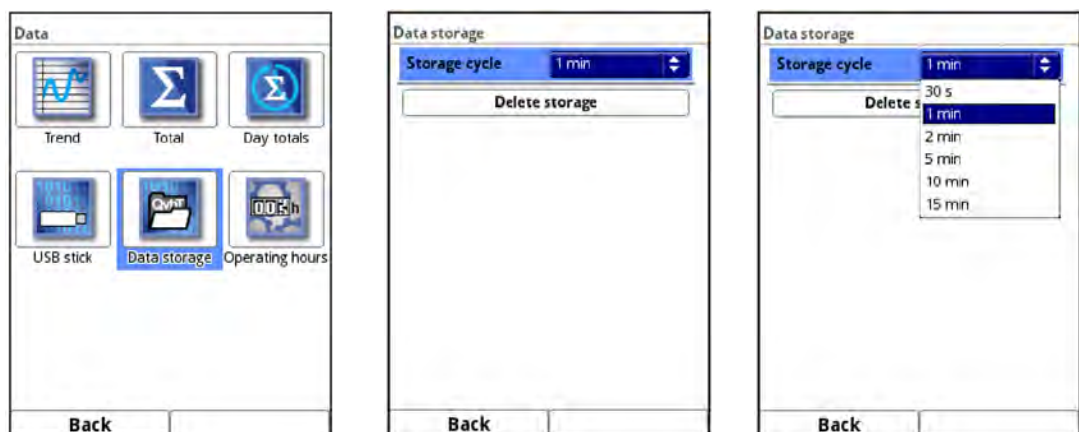

Fig. 35-9 Data Memory

Selection options for the **>Storage Cycle<** are:

- 30 s, 1 min, 2 min, 5 min, 10 min, 15 min

Default setting for the storage cycle: 1 min

The **average value** over the selected cycle is **always** saved, not the instantaneous value at the time of saving.

The measuring system generates a new measurement value every second.

By using **>Delete Storage<** the stored measurement data in the internal data memory can be deleted. The data is password protected to prevent accidental deletion.



Important Notice

Deleted data cannot be restored!

➤ Procedure:

1. Enter the password to delete the data.
2. Confirm password with the right function key **>Enter<**.

35.5.2 Cycle Mode / Clock Control (function can be added via licence)

The clock control of the transmitter is used in areas where no permanent supply voltage can be provided and therefore the measurement is supplied by 12 or 24 V DC via rechargeable batteries or standard batteries.

In order to reduce energy consumption in this case, it is possible to operate the measurement cyclically.

This means that the transmitter measures for a defined time, stores the measured values internally and then goes into an energy-saving sleep mode (powerdown) in which it neither measures nor displays measured values.

After a parameterised time, the transmitter "wakes up" again, measures and stores the measured values. This cycle repeats in the specified time intervals.

The cycle operation / clock control functionality can either be purchased directly or works in the "DL" voltage variant or subsequently as an add-on function licence.



See Chap. "18.1 Device Versions" and "18.2 Add-On Function Licences".

When ordered in **voltage variant "DL"**, the transmitter is equipped with a special power supply unit that consumes extremely little energy in idle state. The function is then immediately available.

If the cycle operation / clock control functionality is **ordered at a later date**, it must first be enabled by the operator. The power consumption here is higher than with the "DL" voltage variant due to the design (use of a power supply unit with DC/DC converter).



See Chap. "36.5.3 Feature Unlock".

In cycle mode / clock control, in addition to the contents of the basic functions (see chapter "35.5.1 Basic Functions"), the **>Operating Mode<** and the **>Measurement Duration<** can also be set.

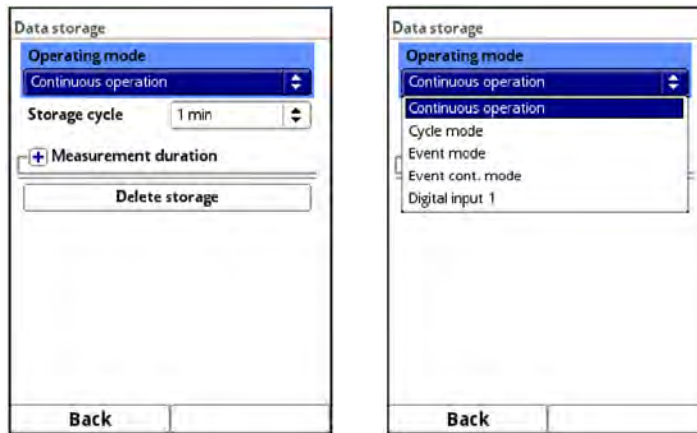

Fig. 35-10 Data Memory Cycle Mode / Clock Control



Recommended Procedure

After completing the parameter settings of the clock control, a test run should ideally take place.

- I. To do this, run the measurement for approx. 3...4 parameterised storage cycles. The display remains dark during this time.
- II. After the time has elapsed, wake up the transmitter by pressing the rotary pushbutton.
- III. Check the function of the measurement in the parameter menu >Data< / >Trend<.

The selected >Operating Mode< determines when and how often the transmitter should take measurements and also save them. Depending on the operating mode, the storage cycle, the event interval and the event type can be set.

The choices for >Operating Mode< are:

- **Continuous Operation**
The transmitter measures continuously, but stores the measured values only at the intervals of the set storage cycle. The permanently determined individual measured values are averaged internally. The average value of the measured values is saved.
- **Cycle Mode**
The transmitter wakes up at the intervals of the set storage cycle, measures for a short time, stores the determined measured values and switches off again automatically ("sleep phase" until the next measurement).
For power-saving reasons, the display remains dark all the time and no measured value is displayed during the measurement cycle.
The transmitter can be woken up for approx. 2 minutes by pressing the rotary pushbutton. If the transmitter is currently in a measurement (in the measurement cycle) at the time of waking up, it takes approx. 5 seconds until the current reading is displayed.
- **Event Mode**
The event mode is an extended cycle mode. It has the same parameters and functionality as the cycle mode. In addition, it is possible to switch to the >Event Interval< by recognising that a definable measurand has been exceeded or undershot (see Page 127). The measurand that triggers event operation is defined via the >Event Type< (see Page 126).
In the event interval the transmitter measures cyclically. The event interval can contain much shorter measuring cycles than the cycle mode. This achieves a better measurement value resolution in important time ranges.

Example:

Measurement of the discharge volume in a discharge channel that is normally dry. Here it is sufficient for the transmitter to measure the value "0" in a storage cycle of

15 minutes and to spend the rest of the time in the sleep phase. If a discharge into the channel is then detected (e.g. using a float switch), the transmitter starts, triggered by the event that occurred, and measures in the set event interval/measurement cycle (e.g. 2 minutes). In the time between measurements, the transmitter goes back to sleep to save energy.



Automatic Change of the Operation Mode

If the conditions of event operation are no longer given, the transmitter checks this change of state for 5 measuring cycles. If this change of state persists uninterruptedly for 5 measuring cycles (event interval), the transmitter changes from >Event Mode< to >Cycle Mode<. This safety function is intended to prevent constant switching back and forth (e.g. due to sloshing movements, electromagnetic interference or similar).

- **Event Continuous Mode**

The event continuous mode and its parameter settings are largely identical to the event mode.

In contrast, the transmitter does **not** switch **off** cyclically in the event interval **during** the event to save energy, but measures in continuous operation. The data is averaged over the entire time span of the event interval and stored in the cycle of the event interval.

The event continuous mode thus consumes slightly more energy than the event mode, but leads to more consistent measurement results for events with strongly fluctuating measured values (e.g. due to waves).



Automatic Change of the Operation Mode

If the conditions of event operation are no longer given, the transmitter checks this change of state for 5 measuring cycles. If this change of state persists uninterruptedly for 5 measuring cycles (event interval), the transmitter changes from >Event Mode< to >Cycle Mode<.

This safety function is intended to prevent constant switching back and forth (e.g. due to sloshing movements, electromagnetic interference or similar).

- **Digital Input 1**

This function enables the transmitter to be "woken up" from energy-saving sleep mode (powerdown), e.g. by an external data logger with digital output, so that it can carry out a measurement and transfer the measurement results to this external data logger (e.g. via Modbus). A synchronisation between the measurement and the external data logger is triggered by the external data logger.

An inverted or non-inverted reaction can be set via the >Logic<.

The >Cycle< defines how long the external signal must be present to wake up the NivuFlow transmitter. The options are: 1 s, 2 s, 5 s and 10 s

Default setting: 1 s

If the input remains permanently activated, further measurements are carried out in the set storage cycle.



Time stamp atypical due to external triggering

Data is saved when the external data logger is triggered and therefore at atypical times (incoming signal plus measuring time of the measurement system).

The identifiers/time stamps of the data series therefore deviate from the usual system.



Fig. 35-11 Operating Mode Digital Input 1: Logic / Cycle

Selection options for the **>Storage Cycle<** are:

- with "Continuous Operation":
30 s, 1 min, 2 min, 3 min, 5 min, 10 min, 15 min
- with "Cycle Mode", "Event Mode", "Event Continuous Mode" and "Digital Input 1":
1 min, 2 min, 3 min, 5 min, 10 min, 15 min, 30 min, 60 min, 2 h, 3 h, 4 h, 6 h, 8 h, 12 h and 24 h

Selection options for the **>Event Interval<** are:

- 1 min, 2 min, 3 min, 5 min, 10 min, 15 min, 30 min, 60 min, 2 h, 3 h, 4 h and 6 h

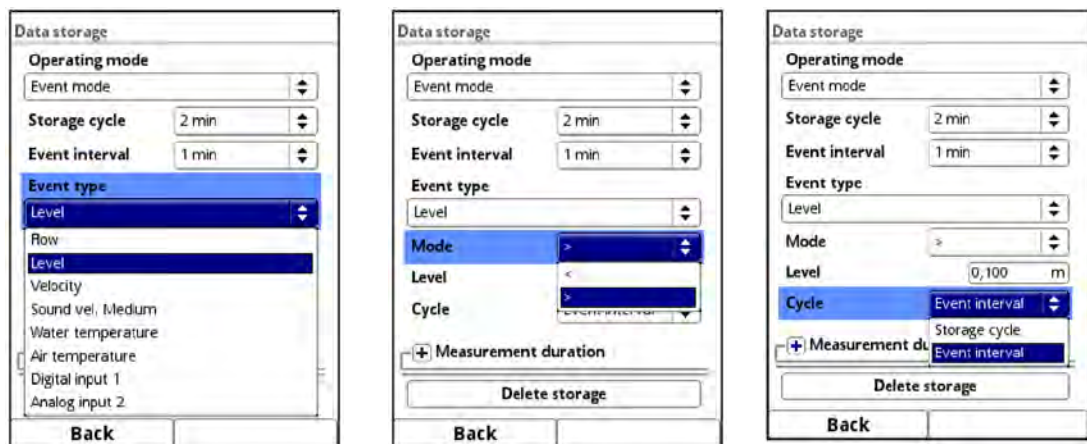

Fig. 35-12 Event Type / Mode / Cycle

>Event Type< (only for Event Mode and Event Continuous Mode)

In the operating modes **>Event Mode<** and **>Event Continuous Mode<**, the event types "Flow", "Level", " Velocity", "Speed of Sound Medium", "Water Temperature", "Air Temperature", "Digital Input 1" and "Analogue Input 2" can be selected.

Info:

For transmitters NivuFlow 600 with multiple measurement places, only measuring point 1 is used for evaluation.

- **Flow:**
The transmitter has changed from the sleep phase to the measurement cycle and has determined a valid flow measurement value.
If this measured value is above the set limit value for "Flow", the transmitter switches to event mode and from now on measures in the parameterised event interval until the flow rate falls below the limit value again for 5 measuring cycles.

The recorded measurement values are saved in the **>Event Interval<**.
By using **>Mode<** it is possible to change from overrun to underrun (see Page 127).

- **Level**
The parameter **>Cycle<** additionally provides to select "Storage Cycle" or "Event Interval".
 - With "**Storage Cycle**", the transmitter reacts in exactly the same way as described under "Flow", only in relation to the level values.
 - With "**Event Interval**", the transmitter also wakes up outside of event mode in the event interval, checks the level measurement and switches to event mode if necessary. This allows the transmitter to react more quickly, but consumes more energy.
- **Velocity**
The transmitter reacts in exactly the same way as described under "Flow", only in relation to the velocity values.
- **Speed of Sound Medium**
The transmitter reacts in exactly the same way as described under "Flow", only in relation to the speed of sound of the medium.
- **Water Temperature**
The transmitter reacts in exactly the same way as described under "Flow", only in relation to the water temperature.
- **Air Temperature**
The transmitter reacts in exactly the same way as described under "Flow", only in relation to the air temperature.
- **Digital Input 1**
Here, a potential-free contact such as a float or pressure switch can be used to switch to event mode in the cycle of the set event interval during the sleep phase. Due to the type of input, very power-saving operation is possible.
- **Analogue Input 2**
This function uses the possibility of switching to event mode by using an external analogue signal (e.g. exceeding of environmental parameters). The parameter setting options are identical to those for "Level".

>Mode< (only for Event Mode and Event Continuous Mode)

Here it is defined by selecting ">" or "<" whether the measurement starts when the entered value is exceeded or not reached.



Fig. 35-13 Measurement duration

>Measurement Duration<

- By setting **>Minimum<**, a minimum measurement duration of the transmitter can be defined. The set time indicates the minimum time for which the transmitter is switched on after measurement start. Extending the minimum measurement duration achieves better averaging in the case of fluctuating flow rates. If the minimum value of the measurement duration is set higher than the cycle time (storage cycle), the transmitter goes into continuous mode.
In addition, a quality check of the measured values is carried out in the background. This prevents no measurement value or a poor measurement value from being stored if the minimum measurement duration is set too short.
- The **>Maximum<** setting limits the measuring time of the transmitter. It thus prevents the quality check running in the background from not producing satisfactory measurement results in the case of difficult measurements and the measurement does not return to the idle state despite cycle mode, but constantly attempts to achieve measurement values.
In that case, for energy saving reasons, a "forced shutdown" is carried out and the invalidity marker "#-1" is stored.
- The maximum measurement duration is set to **>Maximum Auto-< as per default** (checked). In this case, the transmitter determines the optimum maximum setting based on the number of sensors used and activated, analogue inputs and outputs, etc.
If the check mark remains set, the parameter setting is completed and confirmed, then the calculated optimum switch-off time is entered in the **>Maximum<** parameter after the transmitter has been restarted.
NIVUS recommends keeping the factory setting and not entering a manual switch-off time to avoid invalid readings.

Interaction of cycle operation with other data transmission devices

It is sometimes necessary to transfer the measurement data recorded by the NivuFlow transmitter in cyclical operation to data transmission devices from other manufacturers that also operate cyclically.

There are two options for synchronising the two device cycles via Modbus or analogue outputs:

- 1 The external device wakes up the NivuFlow transmitter for a measurement.
To do this, a signal of at least 1 s duration must be sent from the foreign device to the digital input DI1 of the NivuFlow.
- 2 The NivuFlow transmitter wakes up the external device.
This is done using a digital signal (e.g. from digital output DO1).

As soon as both devices communicate, the NivuFlow transmitter **sends** the measurement data to the foreign device.

Information on Option 1:

To wake up the NivuFlow using a non-system data transmission device, select "Digital Input 1" under >Data Memory< / >Operating Mode< during parameterisation.

Under >Logic< you can set whether the input should react inverted or not inverted.

>Cycle< defines the minimum duration for which the external control signal must be present for the NivuFlow to wake up. This serves to prevent external interference signals.

The NivuFlow measures immediately after activation of digital input DI1 and makes its measurement values available via Modbus or analogue outputs. At the same time, it also saves this data in the internal data record. This means that additional measurement data records with "atypical" identifiers/time stamps can be stored there between the storage cycle intervals defined during parameterisation.

If the wake-up signal of the external device is permanently present at DE1, the NivuFlow operates in the set cycle mode until the external signal becomes invalid again.

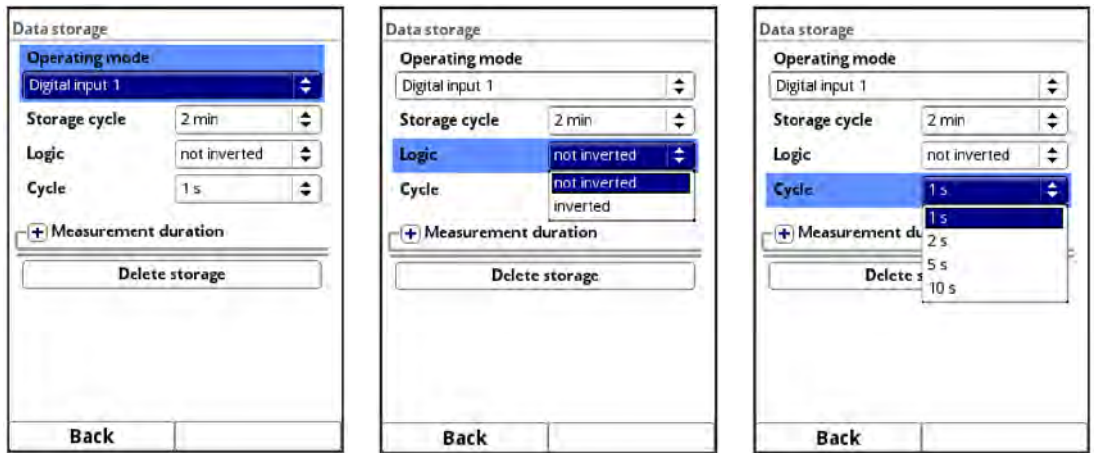

Fig. 35-14 Operating Mode Digital Input 1

Information on Option 2:

If the NivuFlow transmitter is to control a foreign data transmission device via a digital output, select "Measurement valid" for any digital output >Type< under >Application< /> >Inputs/Outputs< /> >Digital Outputs< during parameterisation.

>Hold< defines the duration for which the NivuFlow transmitter maintains the control signal to wake up the external device.

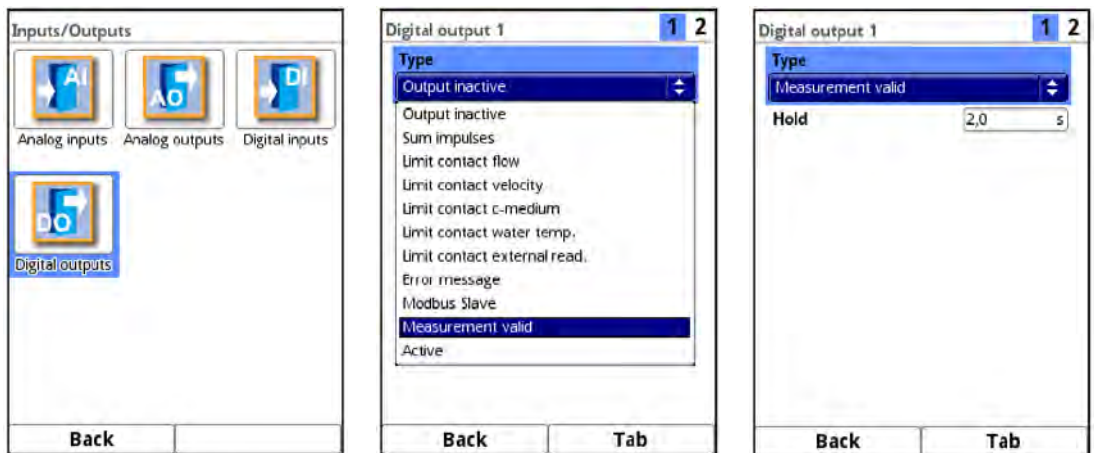

Fig. 35-15 Parameterisation "Measurement valid"

35.6 Operating Hours

Here, the number of total operating hours and the individual daily totals can be read in the displayed table. The table values are 24-hour values in each case.

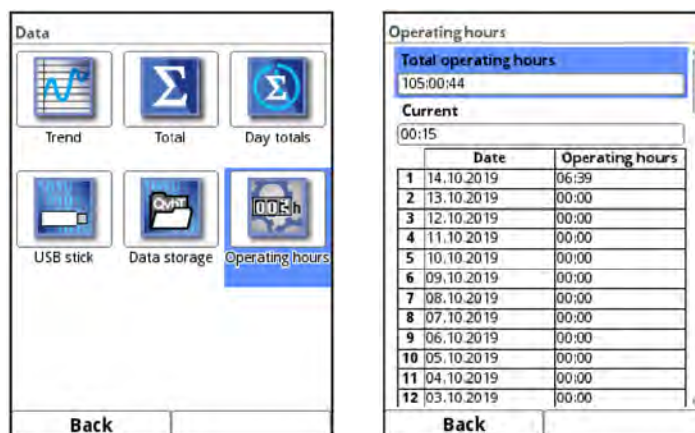

Fig. 35-16 Selection Operating Hours

>**Total Operating Hours**< shows the operating time of the system since the supply voltage was applied. It runs continuously when voltage is applied and stops when the power supply is interrupted.

Display format:

xx:yy:zz (days:hours:minutes)

>**Current**< shows the operating time of the measuring system for the current day. Below this is a table with the daily totals.

A maximum of 100 total values (= 100 days on which a value was recorded) are stored. From value 101 onwards, the oldest value is always overwritten (ring memory).

- ➡ Turn the rotary pushbutton to the right to scroll down in the table; to the left to scroll up again.

In this way, older values can also be displayed. A prerequisite for the display of older values is that the device has also been running for a longer period of time.

Example: 98 values - The device has been running for 98 days

Generally, only the values can be read on which the transmitter was actually in operation.



Note

The operating hours counter is intended for control purposes and for this reason cannot be reset.

36 Parameter Menu System

36.1 Information

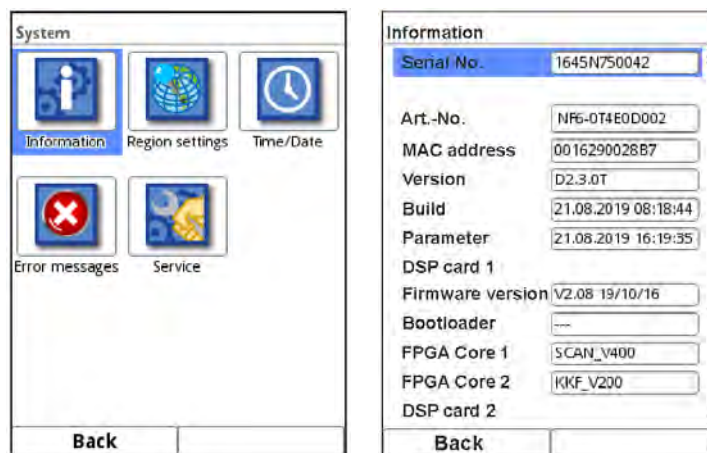

Fig. 36-1 Submenu System/System Information

This menu is a display menu. It contains the following information about the transmitter and the connected sensors and devices:

- Serial number and article number
- MAC Address
- Firmware Version
- Specifications on the bootloader and the WLAN version
- Date of the last software update (firmware) and the last parameter storage
- Specifications on connected/activated sensors (serial and article number and firmware version)

- Information about Open Source Software used (Credits/Licences)
- Specifications on connected Ex Separation Modules pXT0

By pressing the button **>Credits/Licenses<** at the end of the display, the descriptions and links of the open programmes used in the transmitter are saved as pdf to a USB stick to be inserted.

➡ See also Chap. "52 List of Sources of the Licences and Codes used".

This menu is primarily used by the authorised service for (initial) information during commissioning, checking or troubleshooting (on site or by telephone).

36.2 Country Settings

In this menu you can make the following settings:

- (Operating) Language
- Date Format
- Units of the measurement values

A distinction can be made here between the units used in the display and the units used for reading out data.



Fig. 36-2 Region Settings/Language/Date Format

36.2.1 (Operating) Language

All listed languages (Fig. 36-2) provide texts in the national language or the substitute language English.

36.2.2 Date Format

The following date formats can be set:

- DD.MM.YYYY (Day/Month/Year)
- MM/DD/YYYY (Month/Day/Year)

36.2.3 Units

➡ Procedure:

1. Rotate the rotary pushbutton until the field **>Units<** is highlighted blue.
2. Press the rotary pushbutton - the PLUS at the front turns to MINUS and a selection list opens.
3. Turn the rotary pushbutton to the respective selection field.

Decimal Separator

- Comma
- Dot

The decimal separators entered here are only used for the display of the transmitter.

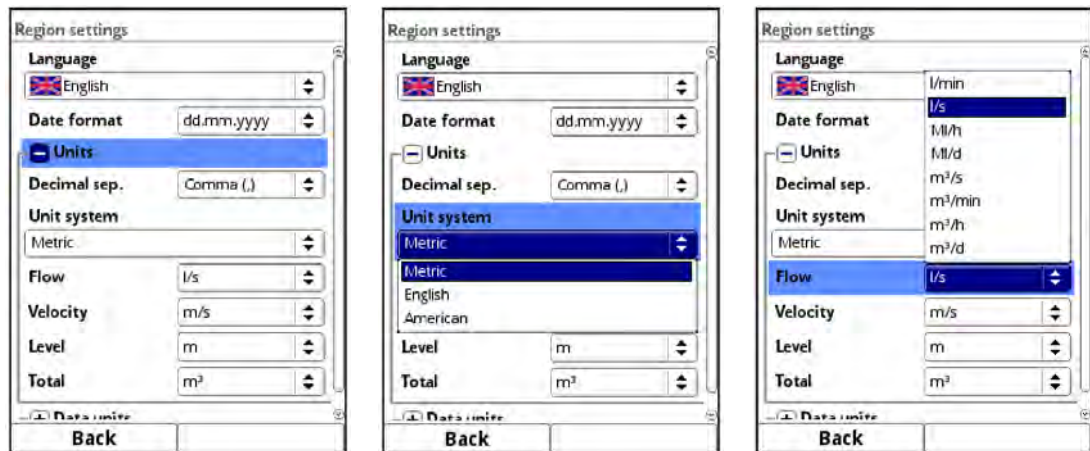

Fig. 36-3 Units System

Units System

The choices are:

- Metric
- English
- American

The adjustable units depend on the selection of the unit system:

- In the metric system - e.g. l, m³, cm/s, m/min etc.
- In the English system - e.g. ft³, in, ft³/s, Mgal/d etc.
- In the American system - e.g. gpm, in, ft/s, mgd etc.

Units for the representation in the display

- Flow
- Flow Velocity
- Level
- Total
- Temperature (only in unit system "English")

36.2.4 Data Units

➡ For the setting >Data Units<, proceed in exactly the same way as for the >Units<.

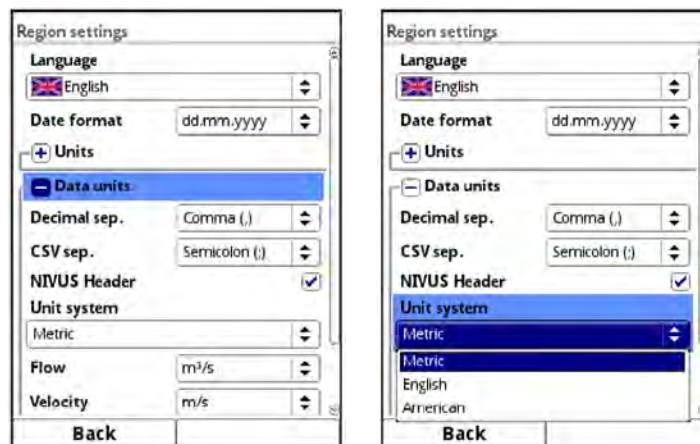

Fig. 36-4 Data Units

The units in which the recorded measurement values are **output** are specified in the >**Data Units**<.

Decimal Separator

- Comma (,)
- Dot

The specification of the decimal separators is important for the correct reading of the data. Especially when evaluating the measurement data with a software in another language (e.g. English Excel), make sure that the decimal separators are correctly selected.

CSV Separator

- Comma (,)
- Semicolon (;)

This selection determines how the individual data are separated in the .csv file when reading out the data.

NIVUS Header

By checking this box, you can activate the saving of the file header with the name of the measurement place, serial and article number of the transmitter as well as information on the firmware version.

Standard Excel applications as well as the NIVUS evaluation software have no problems displaying this useful additional information. If other programmes have problems reading in or evaluating the data, leave the header switched off.

Units System

The choices are:

- Metric
- English
- American

The adjustable units depend on the selection of the unit system:

- In the metric system - e.g. l/s, m³/s, m³/d, cm/s etc.
- In the English system - e.g. ft³/s, in, gal/min, Mgal/d, in/s, yd/s etc.
- In the American system - e.g. gps, gpm, cfs, cfm, cfh, cfd, mgd etc.

Units for the Storage of Measurement Data for

- Flow
- Flow Velocity
- Level
- Total
- Temperature (only in unit system "English")

36.3 Time/Date

In this submenu, the current date and the system time of the transmitter can be changed. The function is needed for the changeover from summer to winter time or after a failure of the internal back-up battery and after a power failure. If the transmitter is operated for a longer period of time, the internal clock may deviate. These deviations can be corrected here.



Note

Changing the system time affects the storage of the data. If data storage is activated, duplicate data or data gaps may occur after system time changes.

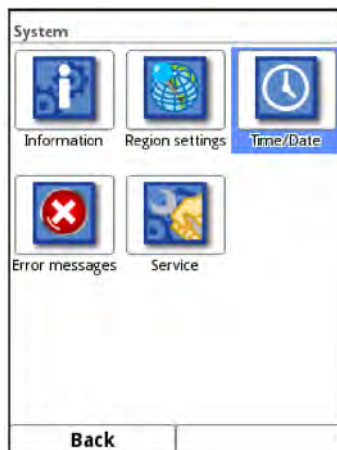

Fig. 36-5 Selecting Time/Date

Setting of the current **system time** and the **time deviation** (UTC).

In addition, a **time server** (SNTP) can be configured here.

This setting can only take effect with an active Internet connection.

A distinction must be made in the settings between transmitters without a modem and transmitters with a modem.

- Transmitters without modem (Type T2/TR/T4/TM/TZ/TD) let you choose between "NIVUS" and "User-defined".
- Transmitters with modem (Type G2/GR/G4/GM/GZ/GD) offer the choice between "NIVUS Auto.", "NIVUS Ethernet", "NIVUS Modem" or "User-defined".

"NIVUS" or "NIVUS Auto." is set **per default**.

Corresponding information is stored in the transmitter for all NIVUS-specific settings; the customised server must be set for "User-defined".

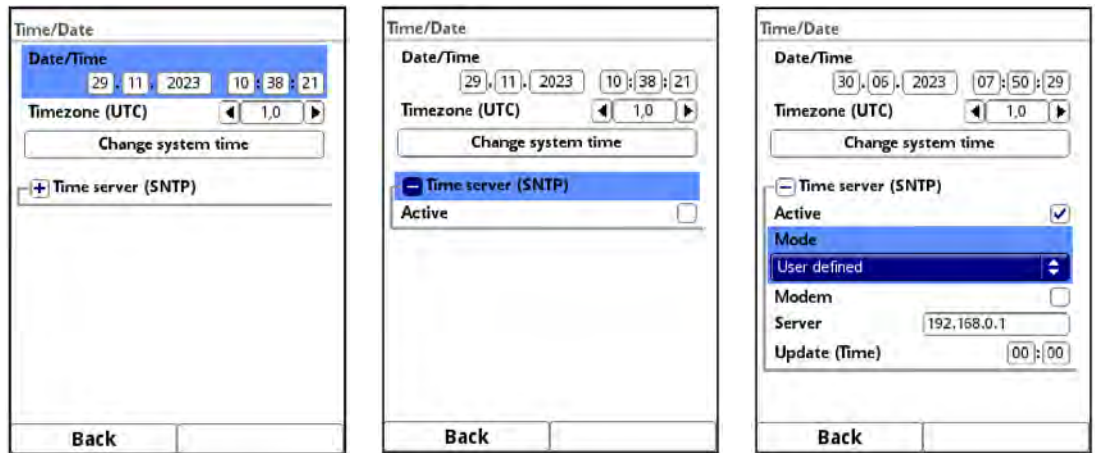

Fig. 36-6 Settings

36.4 Error Messages

In this menu, the current pending error messages and the error memory containing previous errors can be called up. Moreover, the error memory can be deleted.

The data is password protected to prevent accidental deletion.



See also Chap. "Error Messages" starting from Page 169.

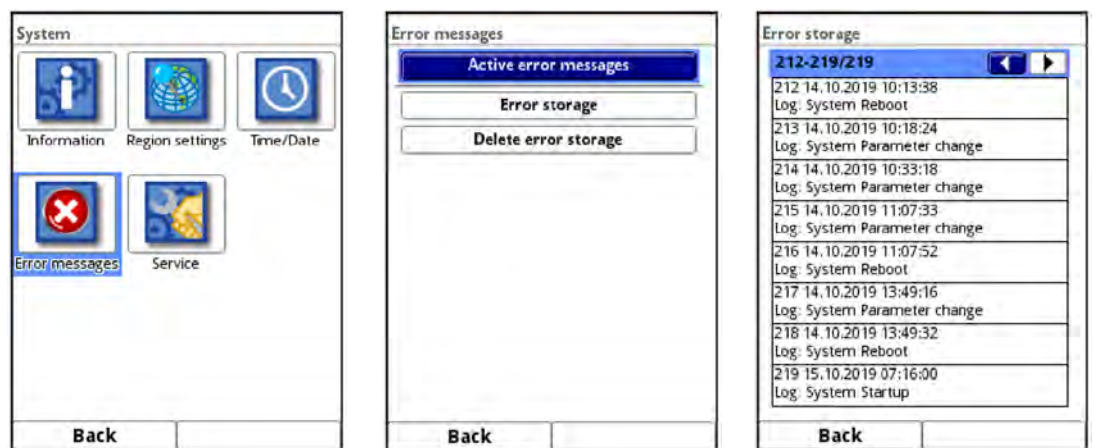

Fig. 36-7 Error Messages

36.5 Service

This submenu contains the following functions:

- Service Level
- Change Password
- Feature Unlock
- Restart (of system)
- Restart Measurement
- Parameter Reset
- Disable coin cell (only for transmitters with modem; Type G2/GR/G4/GM/GZ/GD)
- Update NivuFlow (only in service level with password)

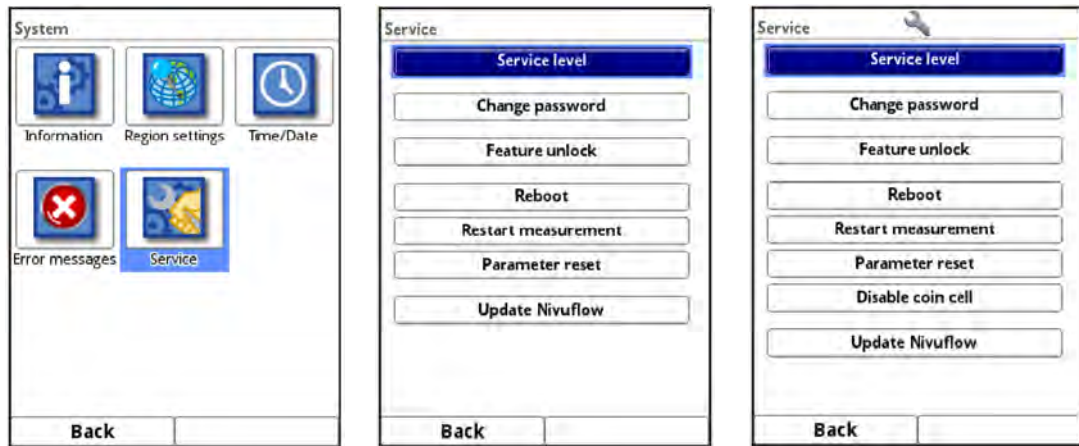

Fig. 36-8 Service

36.5.1 Service Level

Under the service level, which can be activated with the password of the transmitter, additional functions and settings are stored in various places.

The other service levels are reserved for the NIVUS customer service and authorised specialist companies and are therefore also protected with **special service passwords**.

System-relevant changes and special settings for special applications are set here.

These changes may only be made by the NIVUS commissioning personnel!

36.5.2 Change (System) Password

Default setting of the password: "2718"

NIVUS recommends changing this password to protect the system from unauthorised access. The password can be chosen freely, although it is limited to ten characters.

For your own security, we recommend that you only give your password to **authorised persons**.

A password that you have changed **cannot** be recovered by NIVUS!

If the password is lost, the entire system must be reset, which leads to the loss of set parameters and requires a new parameterisation.

Write down the password and keep the note in a safe place.

➡ See also Chapter "32.2 Change Password".

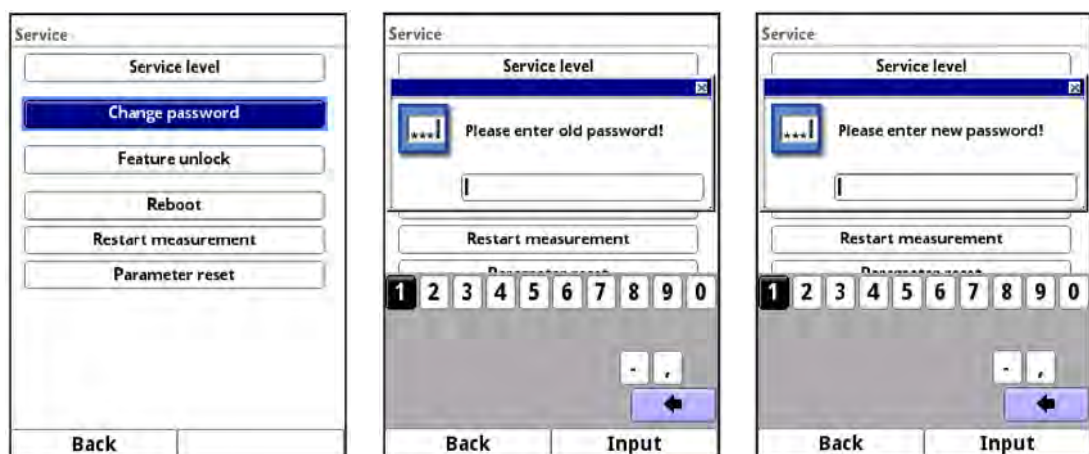

Fig. 36-9 Changing the (System) Password

36.5.3 Feature Unlock

Special (optionally available) functions can be enabled via the feature unlock, provided these have been ordered from NIVUS.



Assignment of the licence to the device unchangeable after being carried out

One licence is only valid for exactly one device and is permanently assigned to it through the serial number.

This assignment **cannot be changed** or **cannot be undone**.

Before assigning, check exactly which device must/should be linked to which licence so that the correct device also receives the licence and can use this feature.

Always pay attention to the operation of the web interface used (NIVUS WebPortal or customer system).

➤ Procedure for Feature Unlock:

1. Click the >Feature Unlock< button.
2. In the opened menu click the >Feature Unlock< button.
3. Enter the function code and confirm with Input.
4. The transmitter confirms the activation of the function with "Successful". The linked licence is shown in the display.
5. The device requests a restart. Afterwards, the functions are available in the corresponding menus and can be parameterised and used.

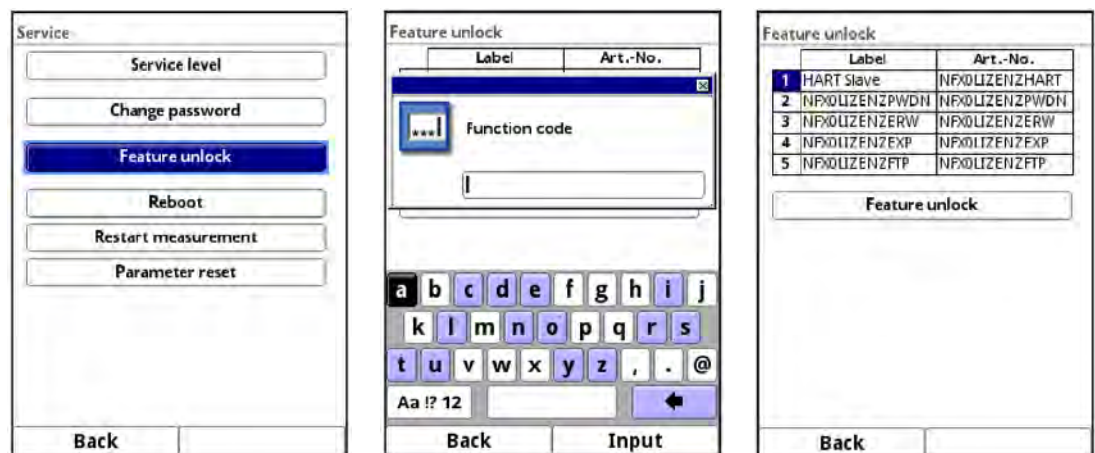

Fig. 36-10 Feature Unlock

36.5.4 Restart

A restart of the transmitter interrupts the current measurement process.

The system boots using the set (saved) parameters. After booting, the system behaves as when it is switched on (analogous to the PC).

This menu point replaces switching the system off and on again. All parameters, counters and stored data are retained.

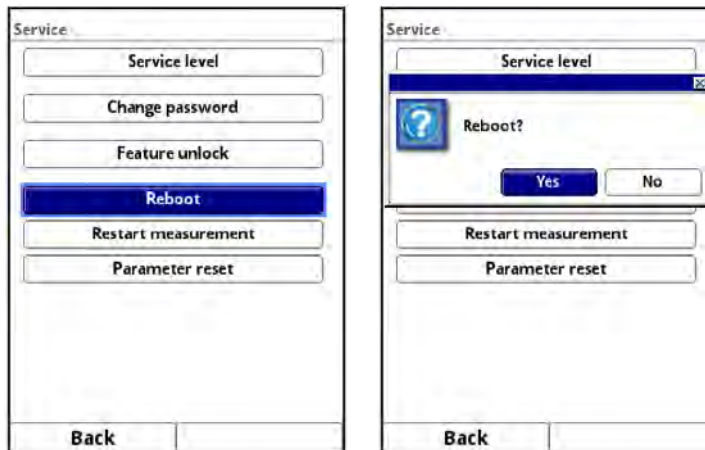

Fig. 36-11 Restart

36.5.5 Restart Measurement

When the measurement is restarted, the currently running measurement is aborted and a new measurement is started.

The transmitter holds the previous display, measurement and output values for the duration of the measurement restart and takes over the new measurement values after the measurement has been restarted successfully.

36.5.6 Parameter Reset

During parameter reset, all parameters are reset to the default settings. Counter readings, changed passwords and stored measurement data are retained in the system.

The actual resetting of the parameters is only carried out after exiting the parameterisation (back to the main menu) and confirming the storage. Until then, the process can still be cancelled.

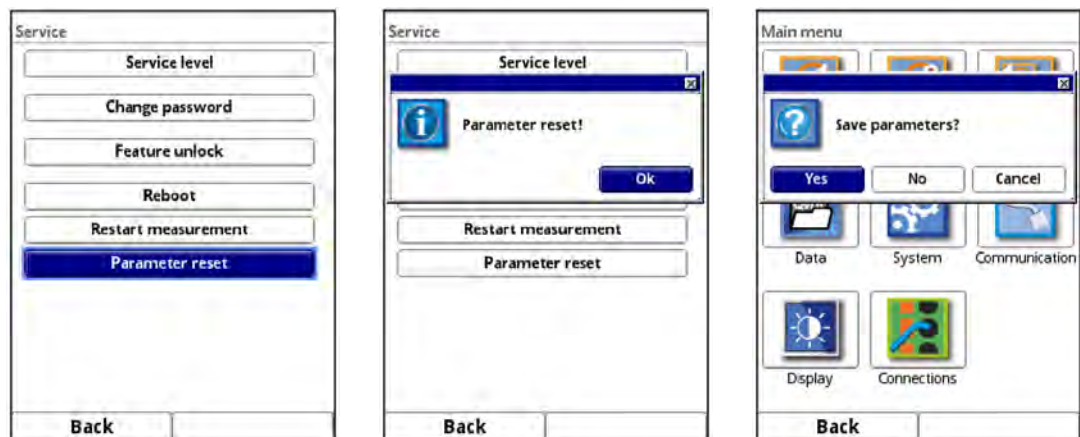

Fig. 36-12 Resetting the Parameters to Default

36.5.7 Disable Coin Cell (Backup Battery)

Disables the coin cell (internal back-up battery in the transmitter) to save energy when the transmitter is stored.



Function is not available for all transmitters

This function depends on the hardware status of the transmitter.

➡ Procedure for disabling (including enabling to operate the transmitter again):

1. Click >Disable Coin Cell< and confirm the message with "Yes".
2. Disconnect the unit from the mains within a few seconds (switch off the power) so that the function remains active. If the transmitter's request "Please switch off the device!" is not complied with, the message remains on the display until the function is cancelled with "Back".



Fig. 36-13 Disable Coin Cell / Putting the Transmitter back into Operation

➡ Procedure for enabling to operate the transmitter again:

1. Connect the transmitter to mains power. The device is initialising.
2. Set the date, time and, if necessary, the time zone according to Chap. "36.3 Time/Date" and exit.
The transmitter operates normally again.

36.5.8 Update NivuFlow

Upload of a NivuFlow firmware saved on USB.
Access possible in the service level.



Important Notice

Update only in consultation with NIVUS GmbH or the responsible local (country) representation.

37 Parameter Menu Communication

In this menu you can establish communication with other devices.

In addition, you can integrate the unit into a network here. Details are only partially described here.

If you do not have the necessary IT knowledge, leave this activity to either an **IT specialist** or the NIVUS **commissioning personnel**.

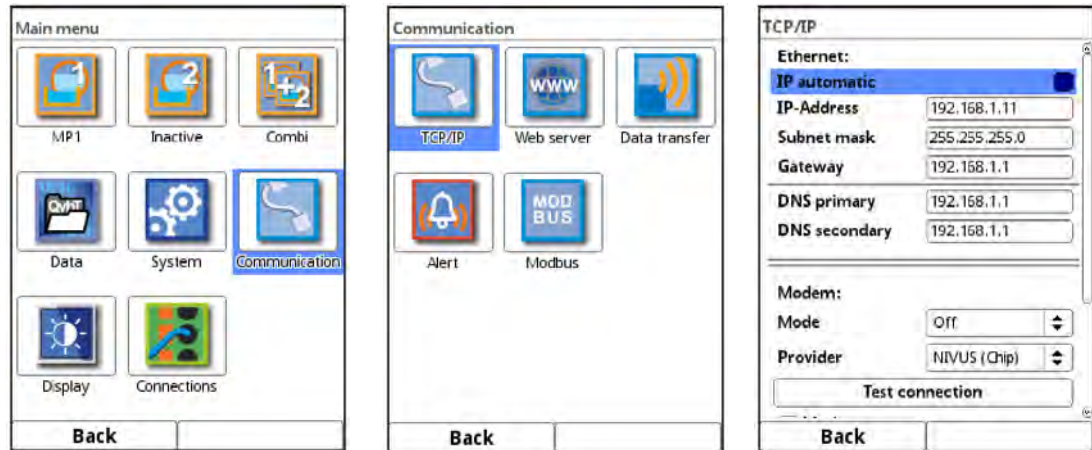

Fig. 37-1 Communication

37.1 TCP/IP

Setting for data transport in a decentralised network. Settings for the IP address and the domain are adjusted here or just displayed.

IP automatic:

If activated (check box), the IP address is automatically obtained from the network via DHCP; the addresses are only displayed and cannot be changed by entering them; if the function is activated, the DNS can be automatically selected in the same way.

IP-Address:

Address within local network.

Subnet Mask:

Description of the local network.

Gateway:

Router address (only if available).

DNS:

Addresses of the name servers for address resolution; split into primary and secondary; except if >DNS automatic< is activated, then only primary.

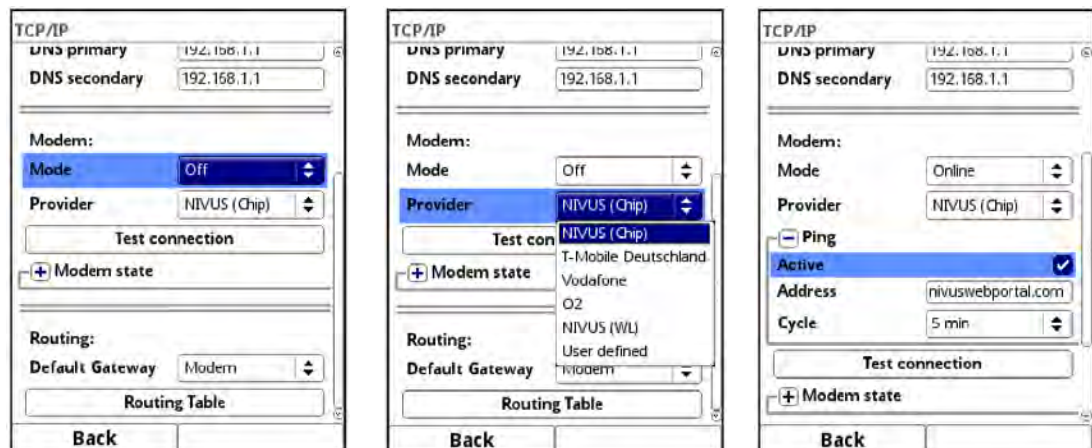

Fig. 37-2 TCP/IP with Modem

Mode (only for transmitters with modem; Type G2/GR/G4/GM/GZ/GD):

Activation of the modem;
 Basic status of the modem:
 Modem "Off" - Basic status Off, is switched on when required and goes online.
 Modem "On" - Basic status On, goes online when required.
 Modem "Online" - Basic status constantly Online.

Provider (only for transmitters with modem; Type G2/GR/G4/GM/GZ/GD):

The service via which the data connection takes place is selected here. Only one SIM card can be used at a time; there is no dual SIM function.
 Currently available: NIVUS (Chip), T-Mobile Germany, Vodafone, O2, NIVUS (WL), user defined.
 If "User defined" is selected, the access data of a non-preconfigured provider is entered. If necessary, this information must be requested there.

Ping (only for transmitters with modem; Type G2/GR/G4/GM/GZ/GD) (only with modem selection "Online"):

Activate self check of the modem by entering the web address and the cycle (30 s, 1 min, 2 min, 3 min, 5 min, 10 min, 15 min, 30 min and 60 min).

Set Up Test Connection (only for transmitters with modem; Type G2/GR/G4/GM/GZ/GD)

The modem checks existing connection options.

Modem State (only for transmitters with modem; Type G2/GR/G4/GM/GZ/GD):

The information on the current status of the modem is displayed here.

SIM Card (only for transmitters with modem; Type G2/GR/G4/GM/GZ/GD) (not with selection NIVUS (Chip)):

Display of information on the customer's SIM card.

Default Gateway (only for transmitters with modem; Type G2/GR/G4/GM/GZ/GD):

Choice of preferred path for data communication: Ethernet interface or 2G/3G/4G modem.

Routing Table:

Data communication in remote networks (WAN) takes place via the >Default Gateway<. However, if individual remote networks can only be reached via the other interface, this can be entered in the routing table.

37.2 Web Server

The settings required for remote operation of the NivuFlow transmitter are made here. The web server makes all (operating) functions available via the Internet as an alternative to on-site operation.

The access data to the HTTP or FTP web server are defined here. The HTTP server allows remote operation via a web browser, the FTP server allows data transfer via an FTP programme.

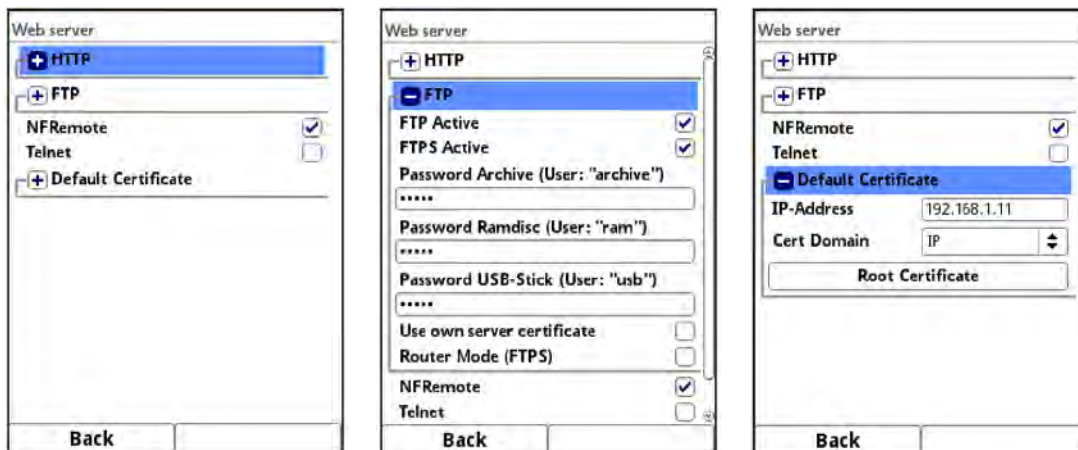

Fig. 37-3 Web Server

HTTP:

- **HTTP Active:**
Activation of unencrypted access via port 80.
- **HTTPS Active:**
Activation of encrypted access via port 443.
- **Username and Password:**
Must be set to enable access.
Default setting: admin / nivus
- **Use own Server Certificate:**
Check box and select file.

FTP:

- **FTP Active:**
Activation of unencrypted access via port 21.
- **FTPS Active:**
Activation of encrypted access via port 21.
- **Password xxx:**
Access to the various "drives" via the user name; only parameterisation of the passwords required;
Default setting: nivus
- **Use own Server Certificate:**
Check box and select file.
- **Router Mode (FTPS):**
Check and enter external IP address or corresponding ports (Port Start / Port Num); special FTP mode for TLS via router.



The parameter settings in the transmitter and router must match.

NF Remote:

- **NF Remote:**
Allow remote access via special application.
Not recommended!

Telnet:

- **Telnet:**
Allow remote access via Telnet.
Not recommended!

Standard Certificate:

- **Standard Certificate:**
Enter / change the certificate used; enter/select IP address and domain type (IP / name) or load >Root Certificate< from USB stick;
the device has its own certificate, but can load a third-party certificate via the USB port if required.

37.3 Data Transmission

The automated cyclical data transmission to the NIVUS WebPortal is defined here. This can be done via the network protocol MQTT, via FTP server or via e-mail.

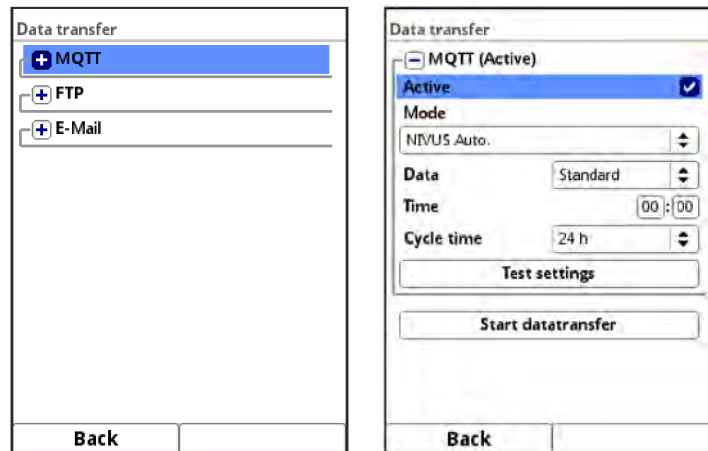

Fig. 37-4 Data Transmission Options / MQTT

MQTT:

The NIVUS WebPortal is pre-configured and available to the user with a chargeable booking. It offers a wide range of options for data display, measurement place visualisation, reporting and analyses.

As an option, the MQTT network protocol is available. This protocol is used to send all data that accumulates in the data memory to an MQTT server.

- **Active:**
Check the box to activate.
- **Mode:**
 - **NIVUS Auto.:**
The system automatically selects whether the data is sent via Ethernet or via the 2G/3G/4G modem.
 - **NIVUS Ethernet:**
Transmits data via Ethernet.
 - **NIVUS Modem:**
Transmits data using the 2G/3G/4G modem.
 - **User Defined:**
 - Modem:**
The MQTT server is reached exclusively via the 2G/3G/4G modem.
 - Broker:**
The Internet address of the server is entered either as a host name or IP address.
 - Port:**
Associated port
 - Encryption:**
Activation of secure (SSL/TLS) communication between client and server and use of the port.
 - User Name and Password:**
Authentication of the transmitter at the broker.
- **Data:**
Determination of the data depth to be transmitted (see also Chap. "35.4 USB Stick").
 - **Standard:**
Basic data

- **Extended:**
Extended data package (available only through bookable licences; see Chap. "18.2 Add-On Function Licences").
- **Expert:**
Maximum data package (available only through bookable licences; see Chap. "18.2 Add-On Function Licences").
- **Time:**
Specify by how many hours/minutes the transmission should be shifted from the set transmission rhythm (cycle time). Examples:
 - >Cycle Time< 6 h and >Time< 01:15
=> Transmissions at: 01:15, 07:15, 13:15 and 19:15 o'clock
But be sure to note: *If the span under >Time< is greater than the span of the >Cycle Time<, the transmissions will still take place in the specified cycle:*
>Cycle Time< 6 h and >Time< 14:00
=> Transmissions at: 02:00, 08:00, 14:00 and 20:00 o'clock.

Individual entry via rotary pushbutton.
- **Cycle Time:**
Time until next data transmission;
Options: 15 min, 30 min, 1 h, 2 h, 3 h, 4 h, 6 h, 8 h, 12 h and 24 h.
- **Test Settings:**
Establish a test connection to the server with the specified values.
- **Start Data Transfer:**
Manual data transmission since the last transmitted time stamp.

FTP (available only when MQTT is inactive):

Transmission to a customer FTP server or to the D2W data portal.

Available as an additional function licence (see Chap. "18.2 Add-On Function Licences" and "36.5.3 Feature Unlock").

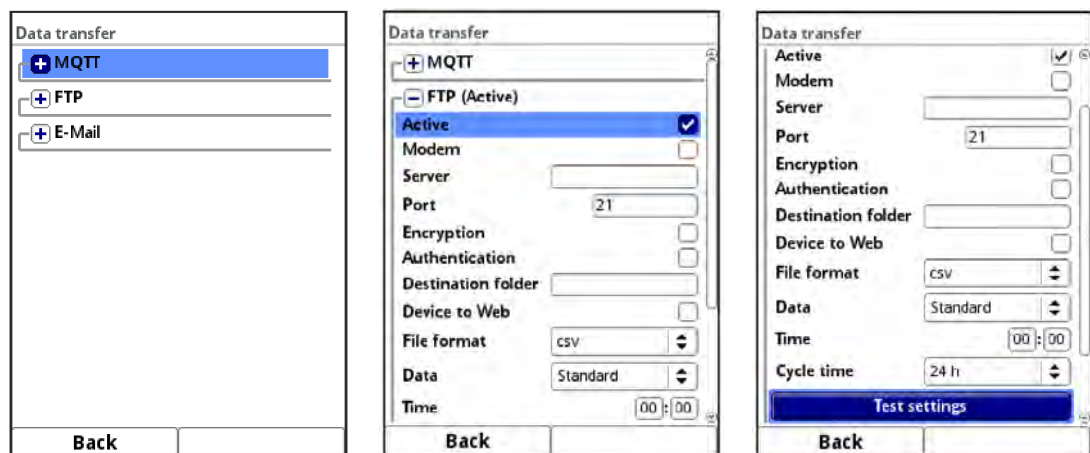

Fig. 37-5 Data Transmission via FTP

- **Active:**
Check the box to activate.
- **Modem:**
Check box to activate (online) the internal modem before the actual transmission.
- **Server:**
Specify server name or IP address.
- **Port:**
Associated port.

- **Encryption:**
Activation of secure (SSL/TLS) communication between client and server.
- **Authentication:**
Activate with user and password-protected FTP access and specify in user name and password accordingly.
- **Destination Folder:**
Enter the destination folder where the files are to be stored.
- **Device to Web:**
Activate when transmitting to the D2W; the Device-to-Web compatible format is applied.
- **File Format:**
There are csv and txt available.
- **Data:**
Determination of the data depth to be transmitted (see also Chap. "35.4 USB Stick").
 - **Standard:**
Basic data
 - **Extended:**
Extended data package (available only via additional licences; see Chap. "18.2 Add-On Function Licences").
 - **Expert:**
Maximum data package (available only through bookable licences; see Chap. "18.2 Add-On Function Licences").
- **Time:**
Specify by how many hours/minutes the transmission should be shifted from the set transmission rhythm (cycle time). Examples:
 - >Cycle Time< 6 h and >Time< 01:15
=> Transmissions at: 01:15, 07:15, 13:15 and 19:15 o'clock
But be sure to note: *If the span under >Time< is greater than the span of the >Cycle Time<, the transmissions will still take place in the specified cycle:*
>Cycle Time< 6 h and >Time< 14:00
=> Transmissions at: 02:00, 08:00, 14:00 and 20:00 o'clock.

Individual entry via rotary pushbutton.
- **Cycle Time:**
Time until next data transmission;
Options: 15 min, 30 min, 1 h, 2 h, 3 h, 4 h, 6 h, 8 h, 12 h and 24 h.
- **Test Settings:**
Establish a test connection to the server with the specified values.
- **Start Data Transfer:**
Manual data transmission since the last transmitted time stamp.

E-Mail (available only when MQTT is inactive):

Transmission to an e-mail address.

Available as an additional function licence (see Chap. "18.2 Add-On Function Licences" and "36.5.3 Feature Unlock").

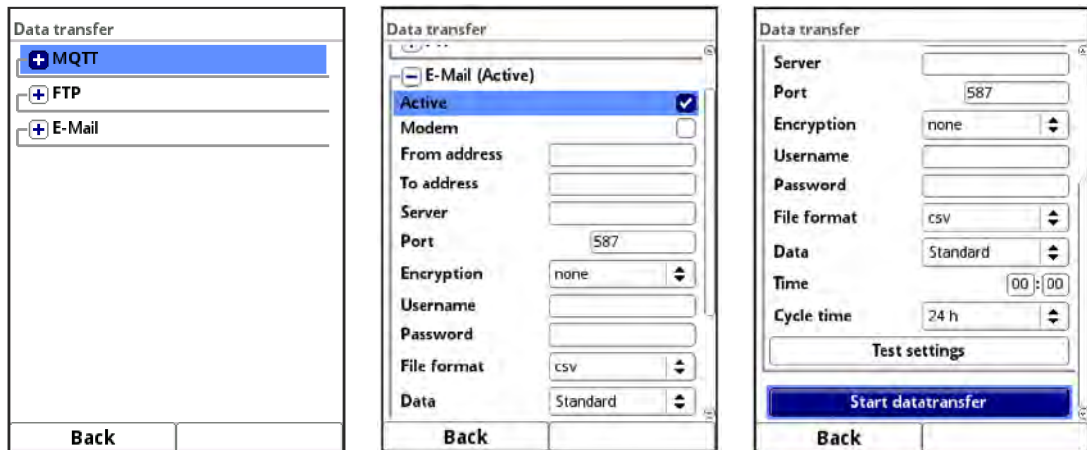

Fig. 37-6 Data Transmission via E-Mail

- **Active:**
Check the box to activate.
- **Modem:**
Check box to activate (online) the internal modem before the actual transmission.
- **From Address:**
E-Mail sender address (needs to be accepted by the SMTP server).
- **To Address:**
E-Mail destination address.
- **Server:**
Specify server name or IP address.
- **Port:**
Associated port.
- **Encryption:**
An encryption via STARTTLS or SSL can be selected optionally.
- **User Name:**
Enter the user name of the e-mail box.
- **Password:**
Enter the password of the e-mail box.
- **File Format:**
There are csv and txt available.
- **Data:**
Determination of the data depth to be transmitted (see also Chap. "35.4 USB Stick").
 - **Standard:**
Basic data
 - **Extended:**
Extended data package (available only via additional licences; see Chap. "18.2 Add-On Function Licences").
 - **Expert:**
Maximum data package (available only via additional licences; see Chap. "18.2 Add-On Function Licences").
- **Time:**
Specify by how many hours/minutes the transmission should be shifted from the set transmission rhythm (cycle time). Examples:
 - >Cycle Time< 6 h and >Time< 01:15

=> Transmissions at: 01:15, 07:15, 13:15 and 19:15 o'clock

But be sure to note: *If the span under >Time< is greater than the span of the >Cycle Time<, the transmissions will still take place in the specified cycle: >Cycle Time< 6 h and >Time< 14:00*

=> Transmissions at: 02:00, 08:00, 14:00 and 20:00 o'clock.

Individual entry via rotary pushbutton.

- **Cycle Time:**
Time until next data transmission;
Options: 15 min, 30 min, 1 h, 2 h, 3 h, 4 h, 6 h, 8 h, 12 h and 24 h.
- **Test Settings:**
Establish a test connection to the server with the specified values.
- **Start Data Transfer:**
Manual data transmission since the last transmitted time stamp.

37.4 Alarm

The >Alarm< parameter menu is divided into various sub-items. These sub-items are >Flow<, >Velocity<, >Water Temperature<, >Speed Of Sound<, >Analogue Input x< and >Digital Input x< ("x" here is a placeholder, the respective number depends on the type-related number of available analogue and digital inputs).

All sub-items are only visible if the analogue and digital inputs have previously been assigned a type under >Application< and thus activated.

➡ See Chap. "34.4.1 Analogue Inputs" and "34.4.3 Digital Inputs".

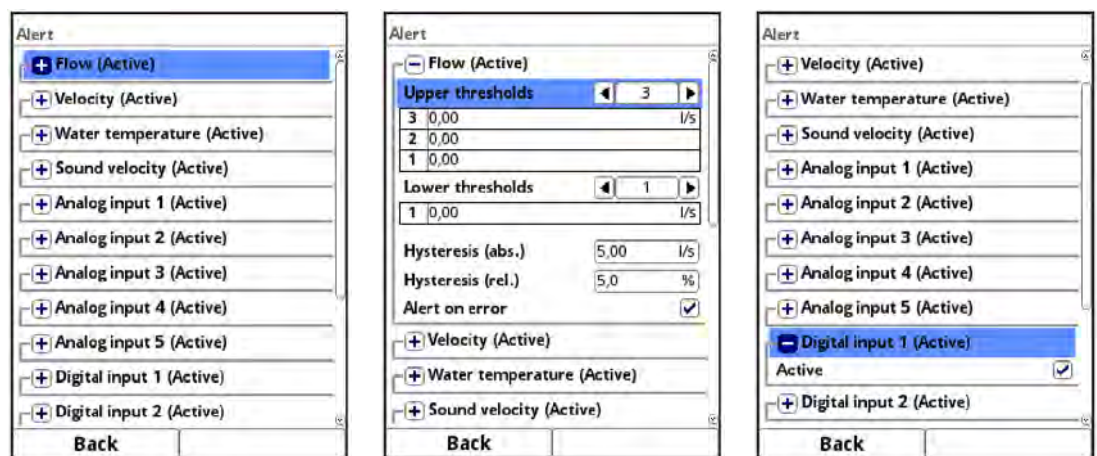

Fig. 37-7 Alarm

For all sub-items (except >Digital input<), up to five different threshold values can be entered via the rotary pushbutton for >Upper Thresholds< and for >Lower Thresholds<. When these are reached, an alarm e-mail (only in connection with the NIVUS WebPortal) is to be issued.

The threshold values are defined by clicking on the fields and typing in numerical values. The transmitter sorts the entered threshold values in descending order. This is done independently of the input sequence.

By specifying >Hysteresis (abs.)< and >Hysteresis (rel.)<, the alarm transmission can be stabilised. To prevent constant status changes due to the smallest fluctuations, the hysteresis function sets a "control threshold" above or below the actual threshold value at a defined absolute or relative distance. Only when this is exceeded or fallen short of, the new change of state is accepted and an alarm transmission (Alarm active/inactive) is triggered.

In addition, the checkbox >Alert on Error< can be set. Then an alarm e-mail (only in connection with the NIVUS WebPortal) is sent in the event of an active pending error. Such errors are e.g. cable faults, interruptions, short circuits etc.



Check >Alert on error< box

NIVUS recommend checking this box to receive an alarm e-mail if a flow velocity sensor is defective. A defect in the flow velocity sensor will cause the flow measurement to fail.

In the sub-item >Digital Input x< a check mark can be set to activate an alarm e-mail (only in connection with the NIVUS WebPortal) when an "active" condition occurs at the digital input.

Default setting: box unchecked.

37.5 Modbus

The transmitter can be integrated into other systems via Modbus.

If required, the NIVUS Modbus TCP/RTU technical description (see Chapter "1.1 Applicable Documentation") can be sent to you on request. For this purpose, please contact the technical office staff at the head office of NIVUS GmbH in Eppingen.

Alternatively, the document is available for download in the download centre on our homepage.

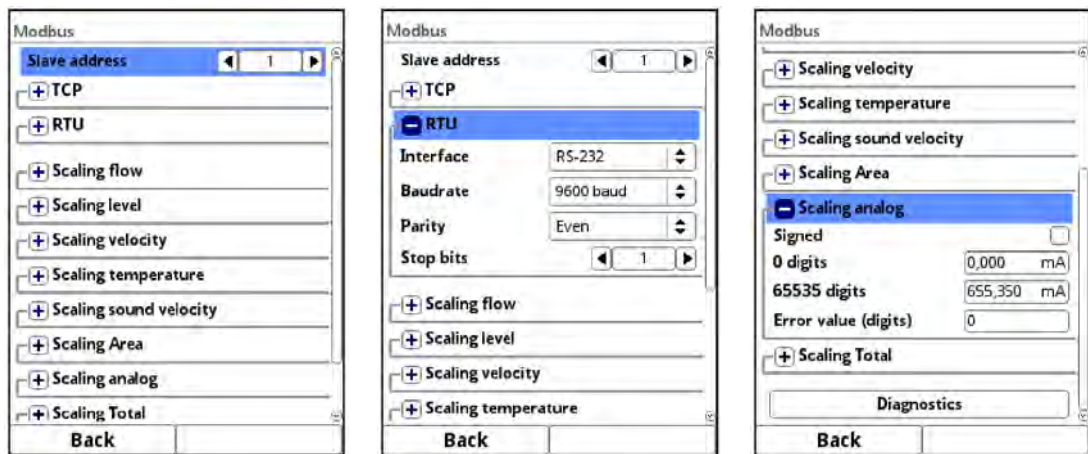

Fig. 37-8 Modbus

The following setting options are available here:

- Slave address (1 to 247 or 255)
- TCP (Port)
- RTU
 - Interface (RS232 or RS485)
 - Baud rate (1200, 2400, 4800, 9600, 19200, 38400, 57600 or 115200 Baud)
 - Parity (None, Odd or Even)
 - Stop bits (1 or 2)

Furthermore, the following scalings can be set:

- Scaling Flow
- Scaling Level
- Scaling Velocity
- Scaling Temperature
- Scaling Sound Velocity
- Scaling Area
- Scaling Analogue
- Scaling Total

By entering the values for 0 / 65.535 digits (or -32.768 / 32.768 if Signed is ticked), the resolution of the measuring range is set.

A value must be entered for "Error Value (digits)" (factory setting: "0") in order to communicate an error message when an error occurs.

Under >Scaling Total< only one value is entered for "Scaling/digit".



Expert knowledge required

These settings require extensive expert knowledge and require the use of NIVUS commissioning personnel or an authorised specialist company.

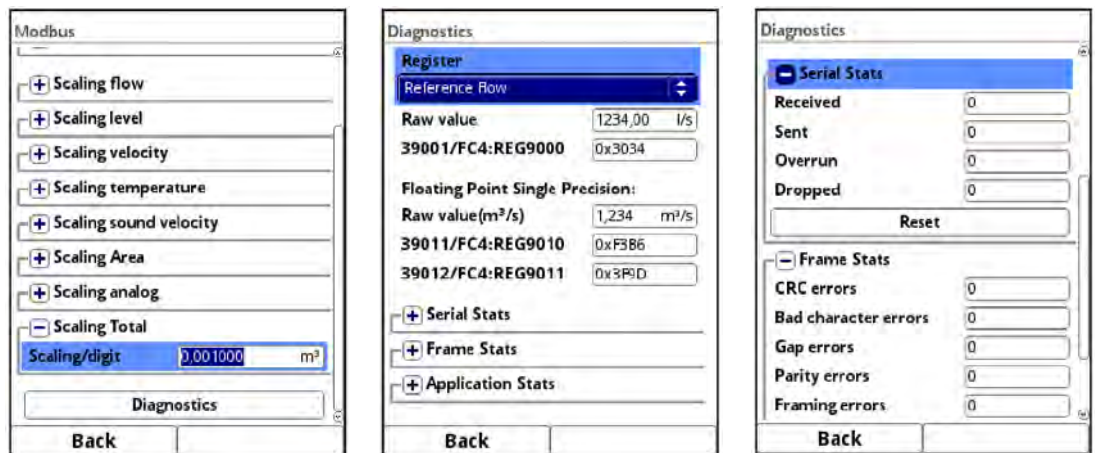

Fig. 37-9 Setting Parameters Scaling / Diagnostics / Serial Stats

Under >**Diagnostics**< the individual registers (flow reference, total reference, flow, level, velocity, water temperature and air temperature) can be viewed in more detail.

The **raw value** and the assignment of the Modbus registers are displayed at the same time. Fixed values can be entered to adjust the scaling/transmission sequence between the transmitter and the connected Scada/PLC.

The statistics (Serial Stats, Frame Stats and Application Stats) are arranged in layers. After viewing, a reset is possible in each case.

Serial Stats concern the serial interfaces (not when accessed via Modbus TCP) and inform about the number of bytes received, sent and discarded/lost.

Frame Stats are about the communication frame and inform about error sources such as the sequence of bytes, checksums, parity, valid packets and other errors.

The **Application Stats** concern the application level and inform about functional errors such as unsuccessful transmissions, unsupported function codes, unoccupied data addresses and other errors.

38 Parameter Menu Display

The following changes can be made in the display menu:

- Backlight (intensity)
- Lockscreen, Dim backlight and Switch off display (period until switch-off)
- Advance Main Display (only for NivuFlow 600 with multiple measurement places; Type T4/G4/TM/GM)
- Name of the five display fields of the main display
- Decimal places of the individual value representations

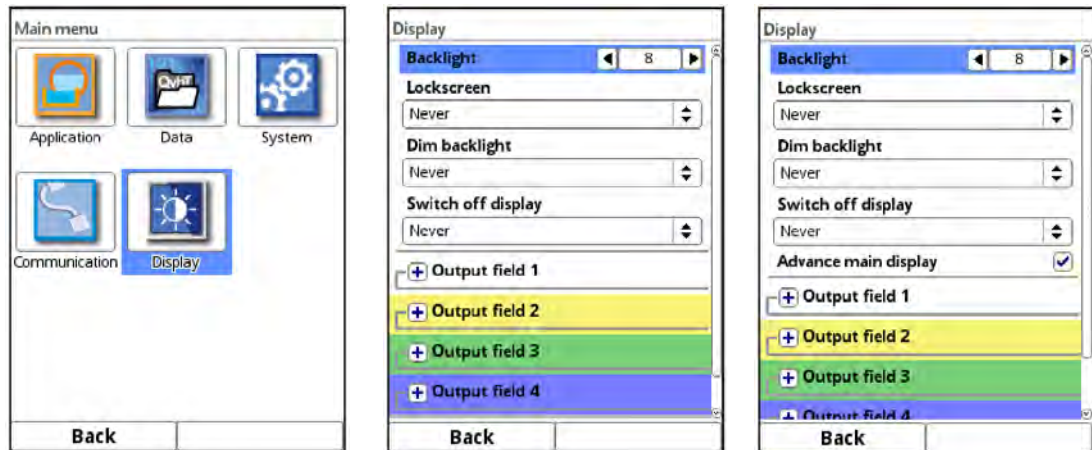

Fig. 38-1 Display/Backlight/Delay Time

Backlight

You can change the backlight in ten levels.

Adjust the backlight to the ambient conditions. Avoid setting the display too bright.

NIVUS recommends setting the automatic display dimming / **Dim backlight** or display switch-off here to protect the display and extend its service life.

The display switches off automatically if you have not used it for a certain time. You can define this time via the delay time / **Switch off display** (Never, 30 s, 1 min, 2 min and 5 min).

As soon as you make any setting on the transmitter (e.g. press a key), the display immediately switches back to the standard brightness.

If you want to ensure that the transmitter display can only be reactivated by authorised persons, use the **>Lockscreen<** function. Then the password for the transmitter must be entered before the display can be used again.

Default settings: >Backlight< on level "8", >Lockscreen<, >Dim backlight< and >Switch off display< = "Never".

Advance Main Display (only for NivuFlow 600 with multiple measurement places; Type T4/G4/TM/GM)

If the box is checked here, the main display automatically switches back and forth between the activated measuring points for types with multiple measurement places. Each measurement place or its current values are displayed for approx. 5 s without further settings.

If the check mark is not set, the main display remains at the last measurement place displayed. By pressing the tab key, the display can be advanced to the desired measurement place. The measurement place to which the displayed values apply is indicated in the main display by the measurement place name in the upper left corner or the dark number in the upper right corner (in "tab mode"):

- 1 = Measurement Place MP1
- 2 = Measurement Place MP2
- 3 = Combi Measurement Place

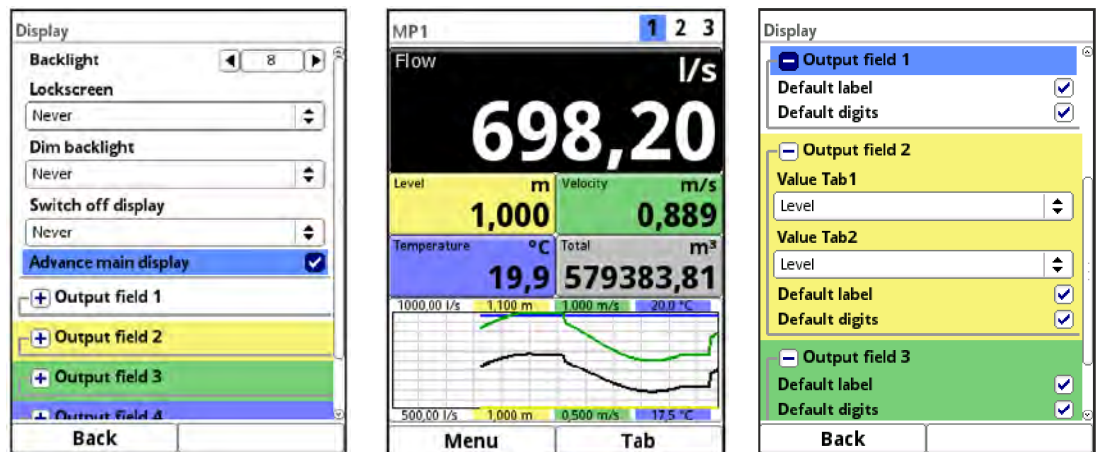

Fig. 38-2 Advance Main Display / Output Fields: assign value

Output Fields

The output fields 1...5 of the main display (flow, level, surface, velocity, speed of sound medium, water temperature, air temperature and total or flow rate for >Measurement Place 1< and >Measurement Place 2< and >Total< for the combi measurement place) can be freely defined in terms of designation and decimal places.

For the output fields 2, 4 and 5, you can also select under >Value< which value should actually be displayed.

The options are:

- Output field 2:
"Level", "Area" (= calculated, hydraulically wetted area of the application), "Speed of Sound Medium", "Analogue input 1", "Analogue input 2" (etc.; depending on type and number of AIs) and "Not active"
- Output field 4:
"Area" (= calculated, hydraulically wetted area of the application), "Speed of Sound Medium", "Water Temperature", "Air Temperature", "Total", "Total positive", Total negative", "Daily average", "Daily average positive", "Daily average negative", "Analogue input 1", "Analogue input 2" (etc.; depending on type and number of AIs) and "Not active"
- Output field 5:
"Area" (= calculated, hydraulically wetted area of the application), "Speed of Sound Medium", "Water Temperature", "Air Temperature", "Total", "Total positive", Total negative", "Daily average", "Daily average positive", "Daily average negative", "Analogue input 1", "Analogue input 2" (etc.; depending on type and number of AIs) and "Not active"

Special feature when using a NivuFlow 600 transmitter with **multiple measurement places** (Type T4/G4/TM/GM): here, the display can be set separately for each measurement place MPx. To do this, open the pull-down menus of the individual output fields at >Value Tab1<, >Value Tab2< and >Value Tab4< and select the desired designation.

The respective "TabX" corresponds to the number at the top right of the main display when advancing is activated.

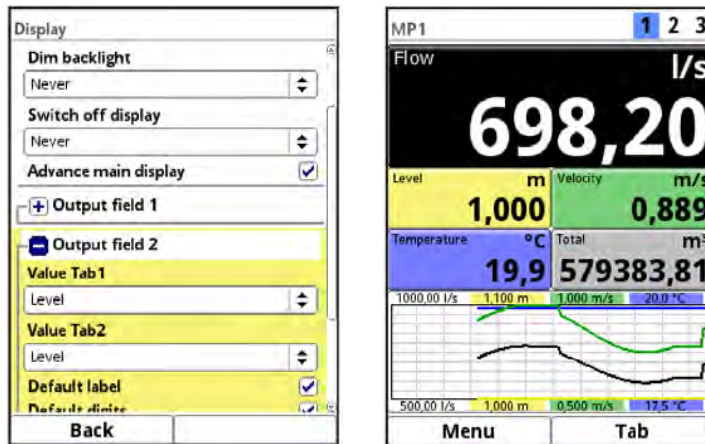

Fig. 38-3 Define Output Fields in case of Multiple Measurement Places / Main Display



Note

The assignment of the values to the fields can **not** be changed in output fields 1 and 3. The change can only be made in the output fields 2, 4 and 5 by selecting "Value" or "Value TabX".
Example: The flow rate is **always** output in the flow field (output field 1), even if you have changed the designation to "Temperature".

The highlighted colours of the output fields correspond to the colours of the values in the main display.

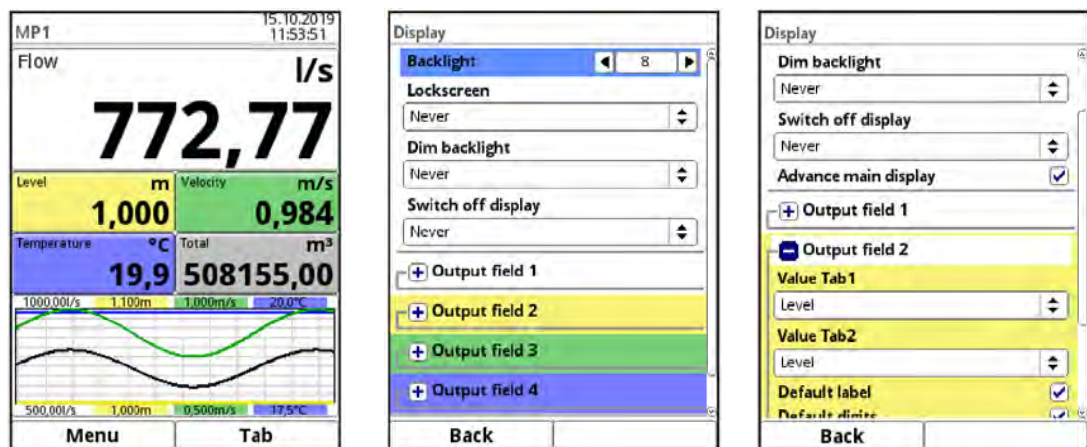

Fig. 38-4 Output Fields, Colours and Settings

➡ Procedure to change the **Label**:

1. Expand the output field.
2. Uncheck the >Default label< box.
3. Enter a new name. This designation is freely selectable up to a maximum of 16 characters.
The new label name you enter does **not** change the value of the fields in the main display.
4. Go "Back" several times to save the parameters.

➡ To save see Chap. "32.1 Save Parameters".

The desired number of **decimal places** can be entered in the same way. A maximum of five decimal places is possible.



Observe the measurement accuracy of the sensors

When setting the decimal places, observe the measuring accuracies of the sensors and the set units of measurement.

The temperature sensor, for example, can only resolve in a 0.1 K grid.

39 Parameter Menu Connections

This submenu is only available for transmitters with multiple measurement places (Type T4/G4/TM/GM).

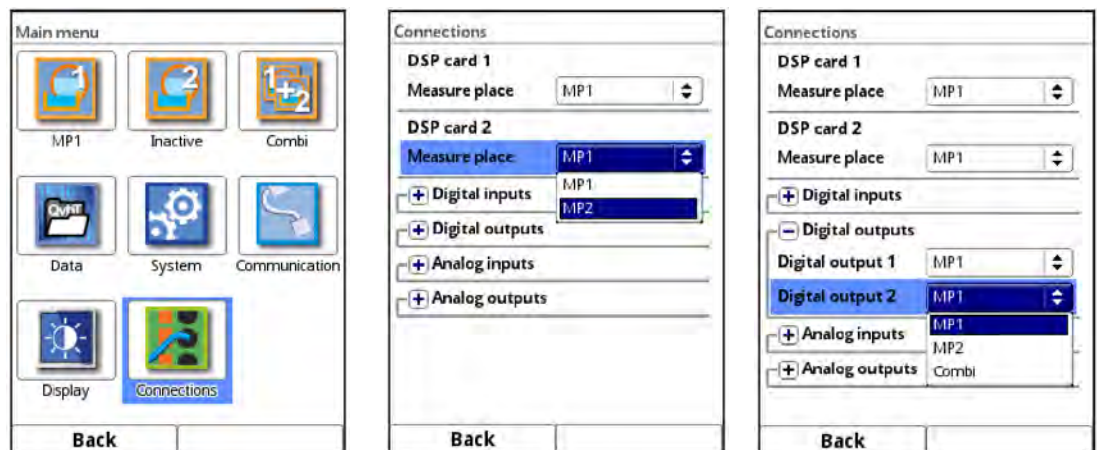

Fig. 39-1 Menu Connections

In this menu, **DSP cards 1 and 2** are assigned to the measurement places, whereby DSP2 must be assigned to measurement place 2 if there are **two different** measurement places (factory setting: MP1).

In addition, the assignment of the terminal strips of the (active) **analogue inputs/outputs and digital inputs/outputs** to the measuring points is also defined here. The order of the assignment is arbitrary. This definition is used to display the determined values (e.g. in the main display and in the parameterisation menus of the measurement places) and, if necessary, the subsequent calculation with the values. The respective inputs/outputs must be assigned to the connections in the menu in advance so that they can be displayed and parameterised in the measurement place menu.

It is also possible to assign inputs and outputs to the virtual combi measurement place (Combi). For example, an analogue input for the consideration of an external flow measurement as a fourth measurement place and/or an analogue output for the output of the total flow.

Diagnostics

40 Basics of the Diagnostics Menu

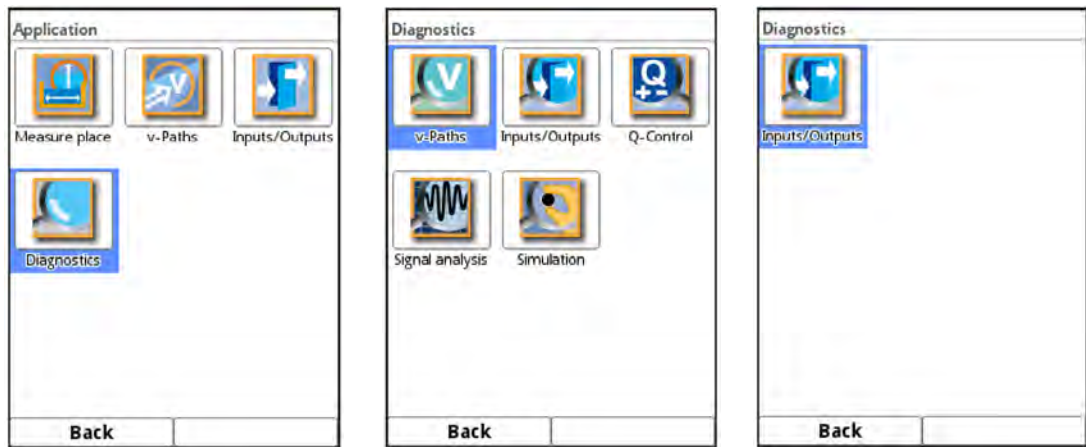

Fig. 40-1 Menu Diagnostics

The menu >Diagnostics< can be found in the >Application< or >MPx< or >Combi< menu. The diagnostics are divided into up to five submenus (five if the flow controller is activated), except in the >Combi< menu, where there is only one submenu (Inputs/Outputs).

The Diagnostics menu and all submenus are purely display and simulation menus. There is no parameterisation possible within the menus.

In this section, the following settings can be checked or simulated:

- v-Paths
- Inputs and outputs (status and simulation) (also for >Combi<)
- Flow Controller (Q-Controller)
- Signal analysis
- Simulation



Important Notice

It is essential to follow the safety instructions for the simulation in Page 167.

Depending on the problem, the Diagnostics chapter can also be very helpful for the user, but the main user is NIVUS customer service.

41 Diagnostics v-Paths

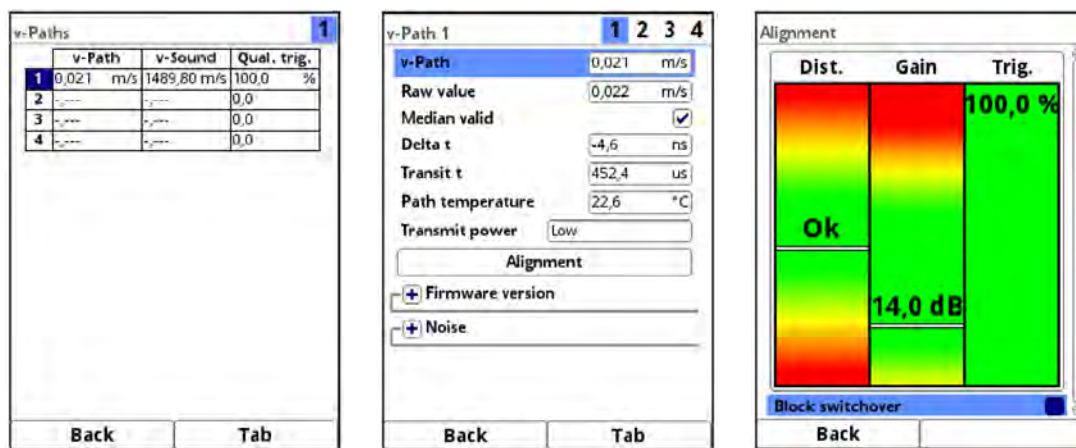

Fig. 41-1 Menu Diagnostics v-Paths

In this menu, hardware information and current data on the sensors/paths can be displayed (see Fig. 41-1). No simulation is possible.

The transmitter starts the menu with an overview that allows you to jump to the individual v-paths.

The following settings or current values are possible/can be read:

- **>v-Path x<**
Measured single path velocity; the Tab key can be used to switch between the individual paths in the display, provided there are at least two paths.
- **>Raw value<**:
Value actually measured
- **>Median valid<**
A checked box indicates that the respective path works within the usual limits; if no tick is set, the path determines atypical values / deviations.
- **>Delta t<**
Measured transit time difference; basis for calculating the velocity v.
- **>Transit t<**
Average signal transit time between sensor 1 and sensor 2 of the respective path.
- **>Path temperature<**
Calculated medium temperature of the respective path.
- **>SonicPro T Resistor<**
This indicates whether the SonicPro T surge protection can be installed without any structural changes (display: "---") or whether a modification (display: "red" or "blue") is required.
⇒ For details of the possible/required modifications to the resistor, see Chap. "Modifying "SonicPro T" Overvoltage Protection" starting on Page 62.
- **>Transmitting Power<**
Classification of the transmitting power into "Low", "Medium" and "High", indicates how much energy the system uses to generate ultrasonic signals. A high value indicates difficult operating conditions, a low value indicates optimum operating conditions.
- **>Alignment<**
Aid for sensor positioning and therefore for path alignment:
 - **>Dist.<** (Distance):
Indicates via the arrow alignment whether the parameterised sensor position must be

corrected due to the real conditions (move together or further away from each other). In the green range the sensor position is optimal, in the yellow and red range it has to be adjusted.

>Gain< (Amplification):

Graphic representation of the transmitting power. Transmitting powers in the green range are optimal. In the yellow range, caution is advised, as interfering signals such as noise could lead to over- or underdrive and thus to a failure of the measurement system. In the red range, measurement is impossible: the measurement place is unsuitable for the measurement method.

>Trig.< (Trigger):

The Trigger display expresses in % how the signal coupling of both sensors behaves relative to each other. Differences in the signal coupling, especially with clamp-on, can lead to a distortion of the measurement.

- **>Lock Switchover<**

In the case of multi-path systems, the display switches continuously from path to path for alignment.

Select the tick to lock the currently selected path for aligning the signal.

- **>Firmware Version<**

Information on the firmware version and the components is stored here. This information is important for the NIVUS service.

- **>Noise<**

- **>Upstream Typical<**

Continuous level (noise) which is output in the measurement range against the flow.

- **>Upstream Maximum<**

Peaks - temporary disturbances such as pumps or similar that are detected against the flow.

- **>Downstream Typical<**

Continuous level (noise) which is output in the measurement range with the flow.

- **>Downstream Maximum<**

Peaks - temporary disturbances such as pumps or similar that are detected with the flow

Rule: the lower the value, the better the signal.

42 Diagnostics Inputs and Outputs (analogue and digital)

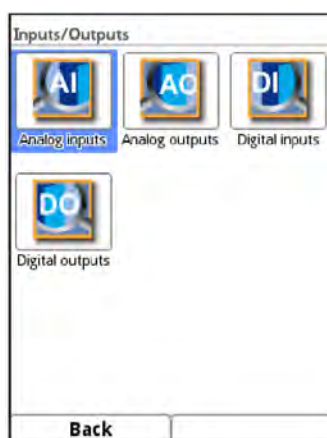

Fig. 42-1 Menu Diagnostics Inputs/Outputs



See also Chapter “34.4 Setting Parameters in the Inputs and Outputs Menu (analogue and digital)”.

42.1 Analogue Inputs

In this menu, the current values present at the analogue inputs of the transmitter can be displayed as mA values as well as the measured values (assigned by means of the measuring span parameterised in the transmitter).

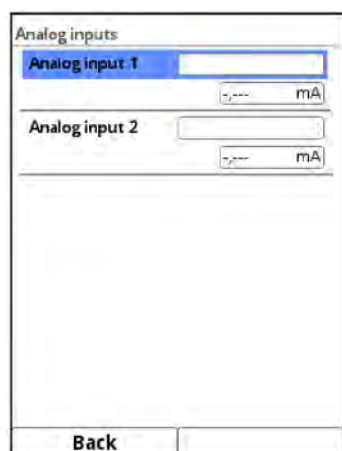

Fig. 42-2 Display of analogue Input Values

With this display, the presence of an external signal and its correct value can be checked without using a measurement device. The immediate conversion into the parameterised measurement span enables the plausibility of the measured value to be checked as well as the correct parameterisation of the input span.

42.2 Analogue Outputs

In this menu, the calculated current values to be output at the analogue transformer and the measured values (assigned by means of measurement span) are displayed.

A password-protected simulation of the individual analogue values is also possible.

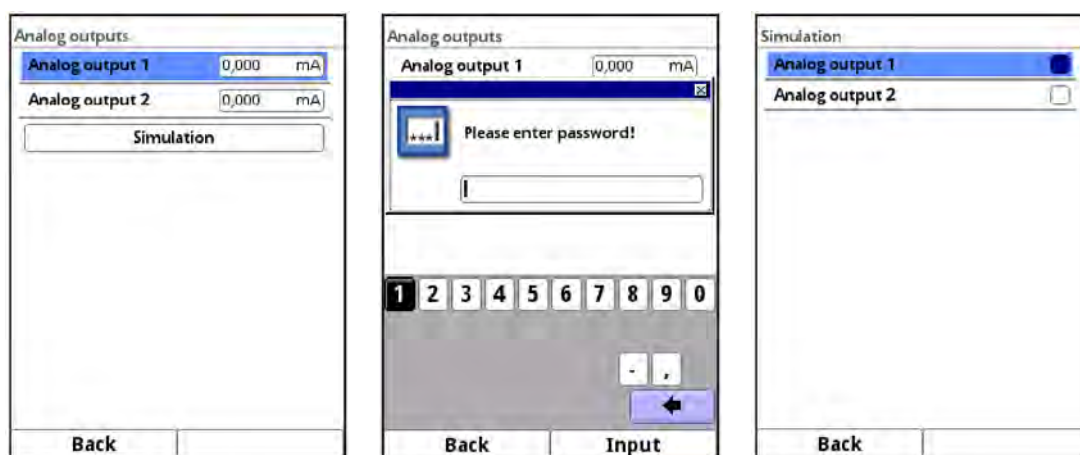

Fig. 42-3 Display of analogue Output Values



The actual flowing currents are not output.

The display only shows the signal that the analogue output converter receives for output.

An external faulty circuit or a defective D/A converter cannot be detected and displayed.

DANGER**Personal injury or property damage**

The simulation of the analogue outputs shall only be carried out by qualified electricians. These specialists must have precise knowledge of the entire regulation and control process of the system.

Prepare the simulation in detail:

- Switch the following equipment to manual operation.
- Switch off the actuators etc. or limit their function.

A safety person is absolutely necessary during the performance!

Disregarding may result in personal injury or damage to the system.

Due to the extremely high risk potential and the incalculable consequences of inadequate or incorrect simulation or disregard of the safety instructions, NIVUS hereby decline any responsibility whatsoever for any personal injury or damage to property in any amount!

DANGER**Effect on Plant Sections**

A simulation of the NivuFlow outputs directly accesses all downstream plant sections without any safety interlock!

Simulations shall only be carried out by qualified personnel.

Be sure to observe the preceding warning!

**Note**

For the previously mentioned safety reasons, access to the simulation is protected by a password.

To protect yourself, only pass on the password to authorised and instructed specialist personnel!

➡ To simulate an analogue output, proceed as follows:

1. Enter the password.
2. Rotate the rotary pushbutton until the desired analogue output is highlighted blue.
3. Press the rotary pushbutton - the analogue output is activated by a tick.
4. Then enter the desired output current as a numerical value.
Make sure that the analogue outputs continue to supply the entered current values until the simulation menu is closed again.
5. Press the left function key to exit the simulation menu.

42.3 Digital Inputs

This menu shows the signals present at the digital inputs.

All available digital inputs (according to the transmitter type) are always displayed, regardless of their activation. The parameterised function of the digital input is shown in brackets after "DI xx".

Inactive digital inputs are identified by the designation "(In. inact.)".

The status of the digital inputs (depending on "inverted"/"not inverted") is indicated by a tick/no tick following the name of the input.

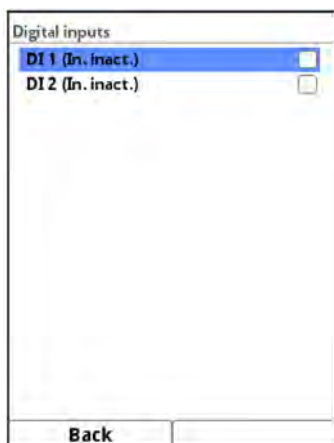

Fig. 42-4 Display of digital inputs

42.4 Digital Outputs

The digital output values available at the transmitter are displayed in this menu.

All available digital outputs (according to the transmitter type) are always displayed, regardless of their activation. The parameterised function of the digital output is shown in brackets after "DO xx".

Inactive digital outputs are identified by the designation "(Out Inact.)".

The status of the digital outputs (depending on "inverted"/"not inverted") is indicated by a tick/no tick following the name of the output.

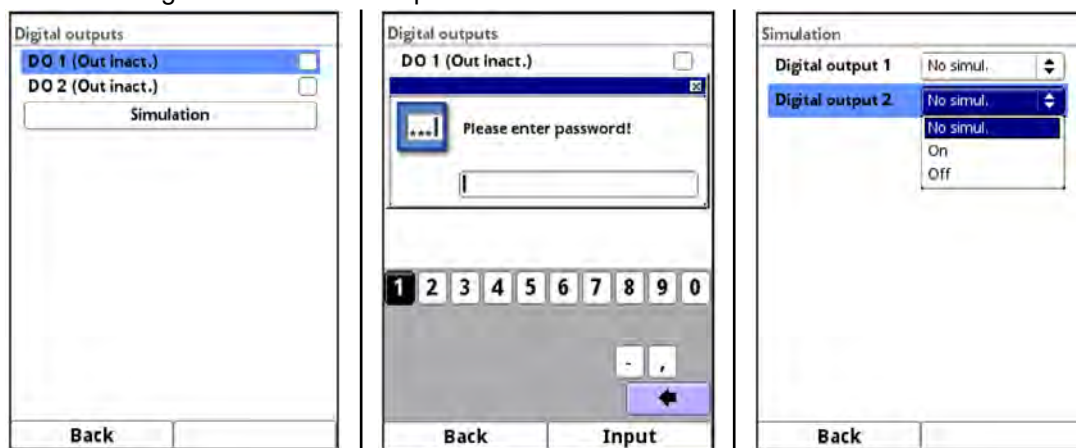

Fig. 42-5 Display of digital outputs

A password-protected simulation of the digital outputs is also available in this menu.

DANGER**Personal injury or property damage**

The simulation of the digital outputs shall only be carried out by qualified electricians. These specialists must have precise knowledge of the entire regulation and control process of the system.

Prepare the simulation in detail.

- Switch the following equipment to manual operation.
- Switch off the actuators etc. or limit their function.

A safety person is absolutely necessary during the performance!

Disregarding may result in personal injury or damage to the system.

Due to the extremely high risk potential and the incalculable consequences of inadequate or incorrect simulation or disregard of the safety instructions, the companies of the NIVUS group hereby decline any responsibility whatsoever for any personal injury or damage to property in any amount!

DANGER**Effect on Plant Sections**

A simulation of the NivuFlow outputs directly accesses all downstream plant sections without any safety interlock!

Simulations shall only be carried out by qualified personnel.

Be sure to observe the preceding warning!

**Note**

For the previously mentioned safety reasons, access to the simulation is protected by a password.

To protect yourself, only pass on the password to authorised and instructed specialist personnel!

➡ To simulate a digital output, proceed as follows:

1. Click the "Simulation" button.
2. Enter the password.
3. Rotate the rotary pushbutton until the desired digital output is highlighted blue.
4. Open the pull-down menu and choose between >No Simulation<, >On< and >Off<. When doing so, remember that the digital outputs continue to supply current until the simulation menu has ended.
5. Press the left function key to exit the simulation menu.

Activating the simulation of each output is done in the same way.

43 Diagnostics Flow Controller (Q-Controller) (function can be added via licence)

The current flow controller/Q-controller status is displayed in this menu. Inputs or a simulation are not possible, the diagnostics are merely a display.



See Chap. "34.5 Setting Parameters of the Flow Controller (Q-Controller) (function can be added via licence)".



Fig. 43-1 Flow Controller (Q-Controller)

- **Status:**
Code/name of the current status.
- **Flow:**
Calculated current flow rate.
- **Level:**
Current filling level.
- **Reference Value:**
The setpoint display corresponds to the reference value set in the >Application< / >Q-Controller< parameter. When using an external, variably adjustable setpoint, the currently used setpoint is displayed.
- **Deviation:**
The (control) deviation results from the setpoint used and the actual value. This deviation is "frozen" at the beginning of the scanning time and the controller operates with this value during the entire scanning time.
- **Sample time:**
Current sample time; frequency at which the flow controller issues a possible new control command (cycle time). The display shows the remaining sample time until the next output.
- **Valve Run Time:**
Current valve run time, calculated travel time of the valve (CLOSE/OPEN). According to the parameterised controller function and depending on the control deviation, this time becomes longer or shorter.
- **Error Delay:**
Current delay time.
In the event of an error, the flow controller normally goes into a programmable error mode. This transition can be delayed to hide/ignore brief error messages. When an error occurs, the error runtime starts to run up until it has reached the set time for the transition to error mode. This run-up time is visible under Error Delay. If the error message disappears during this set time, the error delay display jumps back to "0".
- **Slider CLOSED/OPEN:**
Direction of the slider runtime; the tick is only visible for as long as the corresponding relay is activated.
- **End CLOSED/OPEN:**
Reaching the respective switch is indicated by a tick in the box.
- **Torque/Man. Mode:**
A tick indicates the current status; the first field stands for torque (= automatic mode), the second for (external) manual mode.

44 Diagnostics Signal Analysis

In this menu, the present sensor signal is searched for and evaluated. In addition, the functionality of the sensor can be tested.

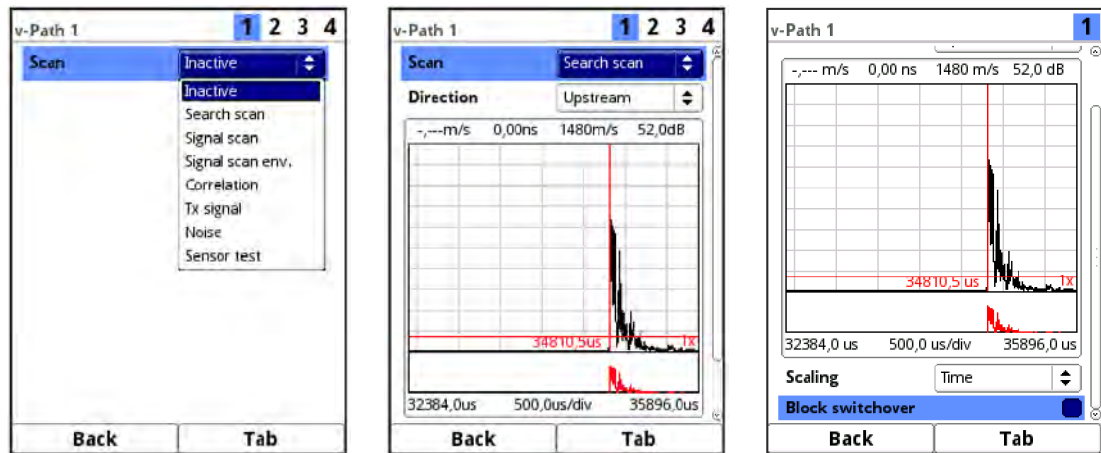

Fig. 44-1 Signal Analysis Selection Menu / Search Scan

In detail, the following options are available:

- **Inactive**
No signal search/evaluation.
- **Search Scan (Fig. 44-1)**
(Rough) search for the signal based on the client's settings and possibly a range extension.

Direction:

- Upstream (against the flow direction)
- Downstream (in the flow direction)
- Up-/Downstream

Scaling of graphic:

- Time
- Distance

V-/H-zoom of the graphic:

Turn the rotary pushbutton to select/deselect the graphic and press to activate;

Selection for V-zoom: 1x, 2x, 5x, 10x, 20x, 50x and 100x

Selection for H-zoom: Reduces the actually displayed/enlarged area within the graphic; the small graphic below shows the respective area in relation to the overall image.

Lock Switchover:

In the case of multi-path systems, the display switches continuously from path to path for alignment.

Select the tick to lock the currently selected path for aligning the signal.

- **Signal Scan (Fig. 44-2)**
More accurate representation of the signal

Direction:

- Upstream (against the flow direction)
- Downstream (in the flow direction)
- Up-/Downstream

Scaling of graphic:

- Time
- Distance

V-/H-zoom of the graphic:

Turn the rotary pushbutton to select/deselect the graphic and press to activate;

Selection for V-zoom: 1x, 2x, 5x, 10x, 20x, 50x and 100x

Selection for H-zoom: Reduces the actually displayed/enlarged area within the graphic; the small graphic below shows the respective area in relation to the overall image.

Lock Switchover:

In the case of multi-path systems, the display switches continuously from path to path for alignment.

Select the tick to lock the currently selected path for aligning the signal.

The **FFT** (Fast Fourier Transformation) box can be checked. The selection changes the scaling from time to frequency range. The signal is thereby divided into its frequency components and can be better examined for interfering signals.

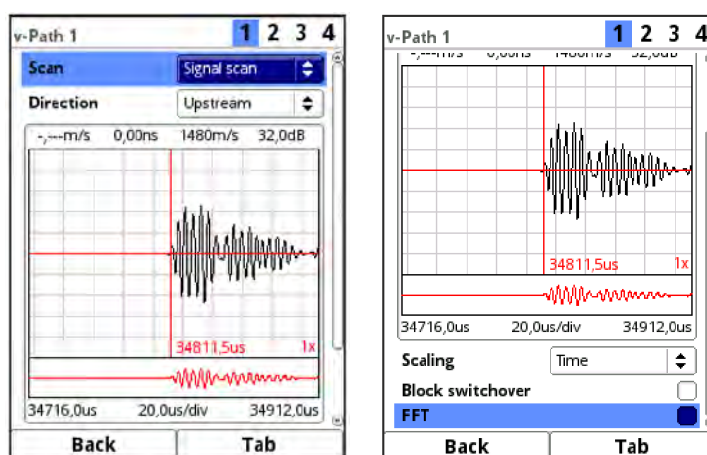

Fig. 44-2 Signal scan

- **Signal Scan Envelope** (Fig. 44-3)
Determining the real start of the upcoming signal

Direction:

- Upstream (against the flow direction)
- Downstream (in the flow direction)
- Up-/Downstream

Scaling of graphic:

- Time
- Distance

V-/H-zoom of the graphic:

Turn the rotary pushbutton to select/deselect the graphic and press to activate;

Selection for V-zoom: 1x, 2x, 5x, 10x, 20x, 50x and 100x

Selection for H-zoom: Reduces the actually displayed/enlarged area within the graphic; the small graphic below shows the respective area in relation to the overall image.

Lock Switchover:

In the case of multi-path systems, the display switches continuously from path to path for alignment.

Select the tick to lock the currently selected path for aligning the signal.

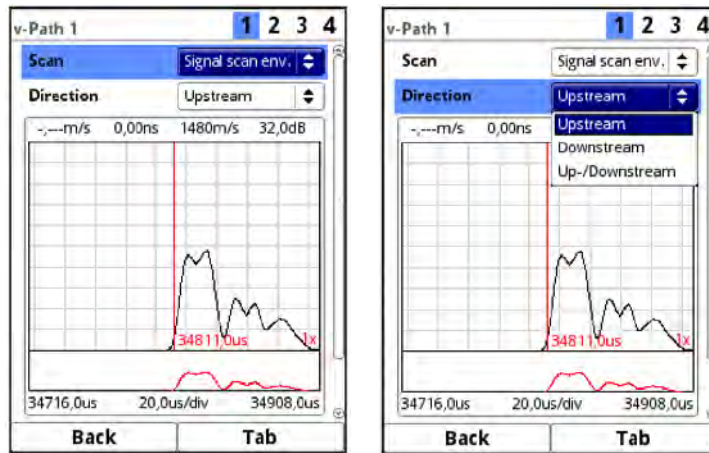

Fig. 44-3 Signal scan envelope

- **Correlation** (Fig. 44-4)
Similarity and temporal shift of the received signals (delta t). Mathematical comparison of the two received signals.

V-/H-zoom of the graphic:

Turn the rotary pushbutton to select/deselect the graphic and press to activate;

Selection for V-zoom: 1x, 2x, 5x, 10x, 20x, 50x and 100x

Selection for H-zoom: Reduces the actually displayed/enlarged area within the graphic; the small graphic below shows the respective area in relation to the overall image.

Lock Switchover:

In the case of multi-path systems, the display switches continuously from path to path for alignment.

Select the tick to lock the currently selected path for aligning the signal.

- **Transmission Signal** (Fig. 44-4)
Optical representation/shape of the signal.

V-/H-zoom of the graphic:

Turn the rotary pushbutton to select/deselect the graphic and press to activate;

Selection for V-zoom: 1x, 2x, 5x, 10x, 20x, 50x and 100x

Selection for H-zoom: Reduces the actually displayed/enlarged area within the graphic; the small graphic below shows the respective area in relation to the overall image.

Lock Switchover:

In the case of multi-path systems, the display switches continuously from path to path for alignment.

Select the tick to lock the currently selected path for aligning the signal.

The **FFT** (Fast Fourier Transformation) box can be checked. The selection changes the scaling from time to frequency range. The signal is thereby divided into its frequency components and can be better examined for interfering signals.

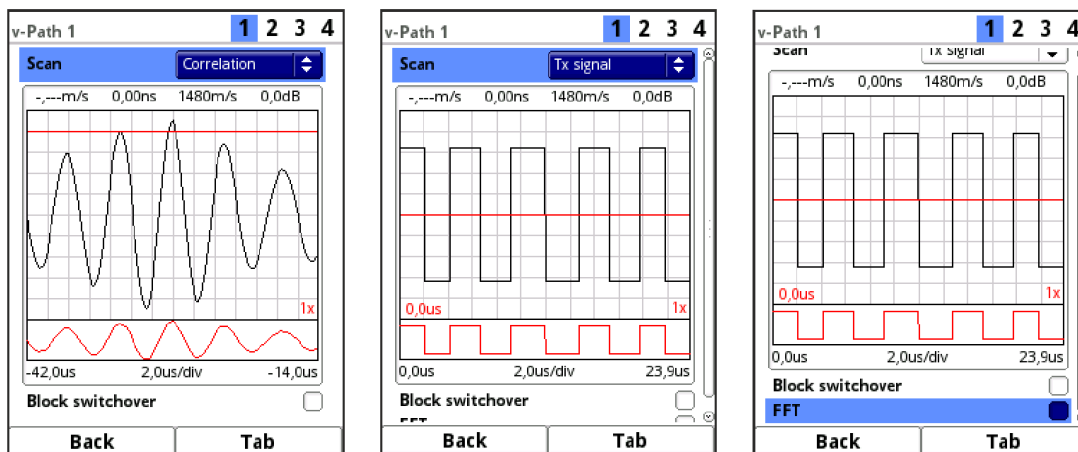

Fig. 44-4 Correlation / Transmission Signal

- **Noise** (Fig. 44-5) Display of all noises (including interference noises) during signal evaluation.

Direction:

- Upstream (against the flow direction)
- Downstream (in the flow direction)
- Up-/Downstream

V-/H-zoom of the graphic:

Turn the rotary pushbutton to select/deselect the graphic and press to activate;

Selection for V-zoom: 1x, 2x, 5x, 10x, 20x, 50x and 100x

Selection for H-zoom: Reduces the actually displayed/enlarged area within the graphic; the small graphic below shows the respective area in relation to the overall image.

Lock Switchover:

In the case of multi-path systems, the display switches continuously from path to path for alignment.

Select the tick to lock the currently selected path for aligning the signal.

The **FFT** (Fast Fourier Transformation) box can be checked. The selection changes the scaling from time to frequency range. The signal is thereby divided into its frequency components and can be better examined for interfering signals.

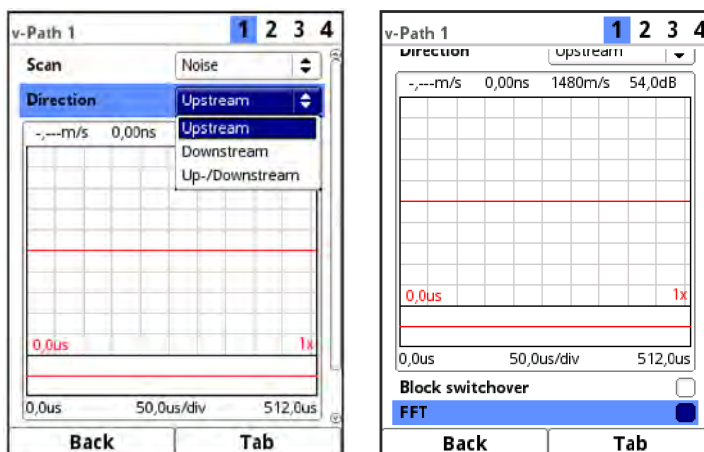

Fig. 44-5 Noise

- **Sensor Test** (Fig. 44-6)
Function test (ringdown test, also possible in air) of a connected sensor. The data collected is mainly used by the NIVUS customer service.

Direction:

- Upstream (against the flow direction)
- Downstream (in the flow direction)
- Up-/Downstream

Signal (testing method):

- Dirac (very short signal)
- Pulse (one signal period)
- Search (search signal)
- Measure (measurement signal)

V-/H-zoom of the graphic:

Turn the rotary pushbutton to select/deselect the graphic and press to activate;

Selection for V-zoom: 1x, 2x, 5x, 10x, 20x, 50x and 100x

Selection for H-zoom: Reduces the actually displayed/enlarged area within the graphic; the small graphic below shows the respective area in relation to the overall image.

Scaling of graphic:

- Time
- Distance

Lock Switchover:

In the case of multi-path systems, the display switches continuously from path to path for alignment.

Select the tick to lock the currently selected path for aligning the signal.

The **FFT** (Fast Fourier Transformation) box can be checked. The selection changes the scaling from time to frequency range. The signal is thereby divided into its frequency components and can be better examined for interfering signals.

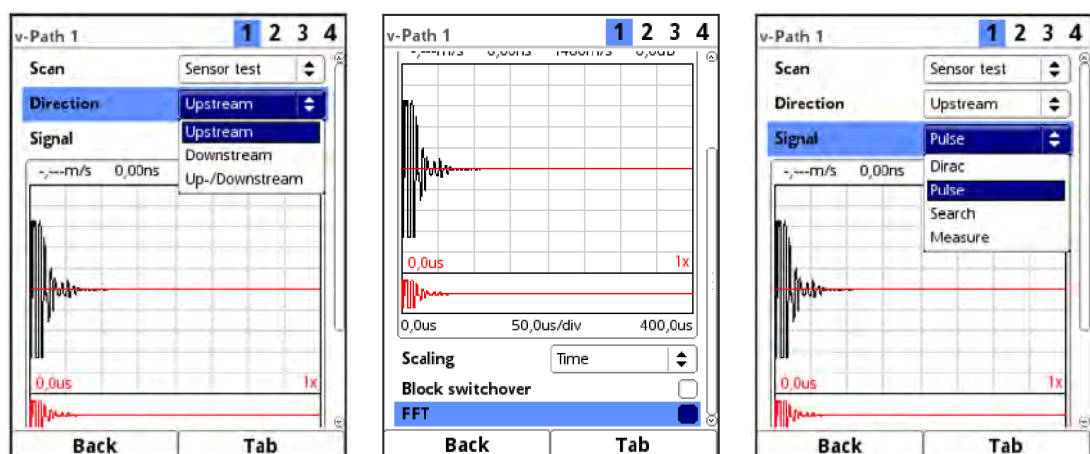

Fig. 44-6 Sensor Test

45 Diagnostics Simulation

In this menu, a theoretical flow can be simulated. The simulation is carried out by entering assumed velocity values. These values are not available in reality.

The transmitter uses these simulated values - based on the dimensions of the programmed channel - to calculate the prevailing flow value.

This value is output at the previously defined analogue or digital outputs.

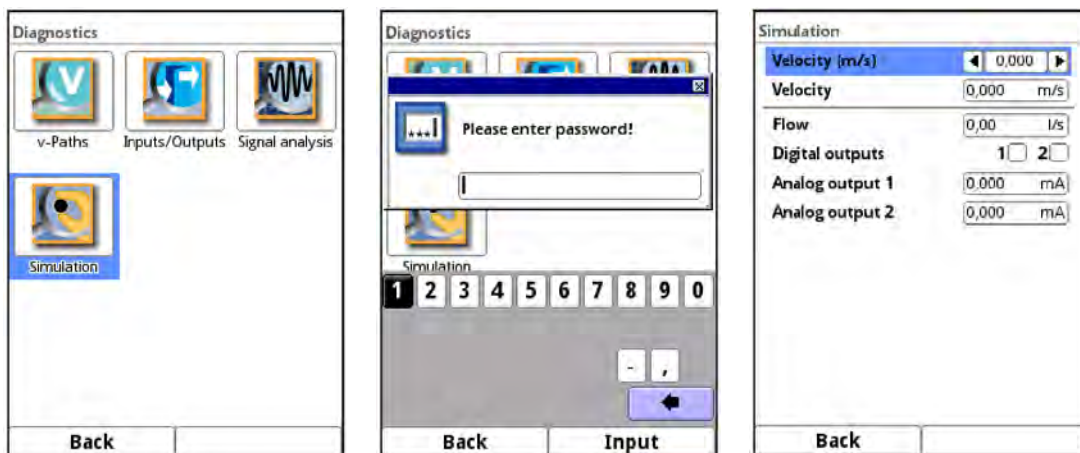

Fig. 45-1 Diagnostics / Simulation

DANGER



Personal injury or property damage

The simulation of analogue and digital outputs shall only be carried out by qualified electricians. These specialists must have precise knowledge of the entire regulation and control process of the system.

Prepare the simulation in detail:

- Switch the following equipment to manual operation.
- Switch off the actuators etc. or limit their function.

A safety person is absolutely necessary during the performance!

Disregarding may result in personal injury or damage to the system.

Due to the extremely high risk potential and the incalculable consequences of inadequate or incorrect simulation or disregard of the safety instructions, the companies of the NIVUS group hereby decline any responsibility whatsoever for any personal injury or damage to property in any amount!

DANGER



Effect on Plant Sections

A simulation of the NivuFlow outputs directly accesses all downstream plant sections without any safety interlock!

Simulations shall only be carried out by qualified personnel.

Be sure to observe the preceding warning!



Note

For the previously mentioned safety reasons, access to the simulation is protected by a password.

To protect yourself, only pass on the password to authorised and instructed specialist personnel!

➡ To start the simulation proceed as follows:

1. Enter the password.
2. Rotate the rotary pushbutton until the velocity is highlighted blue.
3. Enter the desired velocity.
4. Confirm entry with the right function key.
The flow rate value and output values/states calculated from the simulation data entered are automatically displayed in the lower area.
5. Press the left function key to exit the simulation menu.

Error Messages

46 Displayed Error Messages, Cause of Error and Troubleshooting

#	Error Message	Cause of Error	Troubleshooting Measure(s)
1	Q-Controller External Reference Value	Reference value fed in via analogue input is invalid	(1) Make sure that the cable connection between the transmitter and the external reference value generator is correct. (2) Make sure that the settings for the analogue input match the actual external reference value spectrum.
2	Q-Controller Q invalid	Q measurement is invalid, controller unable to work	Check velocity and height measurement for correct parameterisation and measurement values.
3	Q-Controller Torque	Torque input has been activated; controller application measures a torque value that is too high	(1) Check the correct connection of the digital input, torque and the measurement value signal. (2) Check the parameterised torques in the transmitter. (3) Check the actual torque on the slide valve.
4	Analogue Input Value too high	Analogue input value too high	Make sure that the settings for the analogue input match the actual external reference value spectrum. Maximum value: 20.5 mA
5	Analogue Input Value too low	Analogue input value too low	Make sure that the settings for the analogue input match the actual external reference value spectrum. Minimum value: 3.75 mA at 4-20 mA
27	Hardware Battery (3V)	Voltages too high or too low (internal battery)	Contact the NIVUS hotline (serial number and exact error message required).
28	Hardware Power Adapter (15V)	Voltages too high or too low	(1) Make sure that the power supply is stable on the mains side. (2) Disconnect the transmitter from the mains for ten minutes and then reconnect it. (3) Contact the NIVUS hotline (serial number and exact error message required).
30	Hardware System (5V)	Voltages too high or too low	(1) Make sure that the power supply is stable on the mains side. (2) Disconnect the transmitter from the mains for ten minutes and then reconnect it. (3) Contact the NIVUS hotline (serial number and exact error message required).
31	Hardware Logic (3.3V)	Voltages too high or too low	(1) Make sure that the power supply is stable on the mains side. (2) Disconnect the transmitter from the mains for ten minutes and then reconnect it. (3) Contact the NIVUS hotline (serial number and exact error message required).

#	Error Message		Cause of Error	Troubleshooting Measure(s)
32	Hardware	Logic (1.8V)	Voltages too high or too low	(1) Make sure that the power supply is stable on the mains side. (2) Disconnect the transmitter from the mains for ten minutes and then reconnect it. (3) Contact the NIVUS hotline (serial number and exact error message required).
33	Hardware	DRAM (0.9V)	Voltages too high or too low	(1) Make sure that the power supply is stable on the mains side. (2) Disconnect the transmitter from the mains for ten minutes and then reconnect it. (3) Contact the NIVUS hotline (serial number and exact error message required).
34	Hardware	I ² C	Error in the communication of the plug-in cards	(1) Make sure that the power supply is stable on the mains side. (2) Disconnect the transmitter from the mains for ten minutes and then reconnect it. (3) Contact the NIVUS hotline (serial number and exact error message required).
35	Hardware	Slot Power-down	Plug-in card was restarted due to too many errors (defect)	Contact the NIVUS hotline (serial number and exact error message required).
41	Internal Memory	Persistent	Memory error PseudoRam on SD card	(1) Disconnect the transmitter from the mains for ten minutes and then reconnect it. (2) Contact the NIVUS hotline (serial number and exact error message required).
42	Internal Memory	Persistent Backup	Memory error PseudoRam on SD card	(1) Disconnect the transmitter from the mains for ten minutes and then reconnect it. (2) Contact the NIVUS hotline (serial number and exact error message required).
43	Internal Memory	Archive	Memory error archive system on SD card	(1) Disconnect the transmitter from the mains for ten minutes and then reconnect it. (2) Replace the SD card with an equivalent one. (3) Contact the NIVUS hotline (serial number and exact error message required).
44	System	Reboot	Device was booted manually (also update)	No action necessary as no error.
45	System	Hardfault	Restart after programme sequence error	Contact the NIVUS hotline (serial number and exact error message required).
46	System	Watchdog	Restart after programme sequence error	Contact the NIVUS hotline (serial number and exact error message required).
47	System	Bootloader	Error in bootloader	Contact the NIVUS hotline (serial number and exact error message required).
48	System	Startup	Cold Start (power on)	No action necessary as no error.
49	System	Time set	Time was set	No action necessary as no error.

#	Error Message		Cause of Error	Troubleshooting Measure(s)
50	System	Time Server (SNTP)	Time was set via network protocol	No action necessary as no error.
51	System	NFE Box	NFE does not respond	<ol style="list-style-type: none"> (1) Make sure that the cable connections between the transmitter and NFE are correct. (2) Ensure correct parameterisation in the transmitter. (3) Restart transmitter via >System< / >Service<. (4) If the error message appears again, contact the NIVUS hotline (serial number and exact error message required).
62	v-Path	Communication	DSP card responds with invalid telegram	<ol style="list-style-type: none"> (1) Restart transmitter via >System< / >Service<. (2) Contact the NIVUS hotline (serial number and exact error message required).
63	v-Path	Logic	DSP card invalid	<ol style="list-style-type: none"> (1) Restart transmitter in menu >System< / >Service<. (2) Contact the NIVUS hotline (serial number and exact error message required).
64	v-Path	Wrong response	DSP card error message (reset or similar)	<ol style="list-style-type: none"> (1) Restart transmitter via >System< / >Service<. (2) Contact the NIVUS hotline (serial number and exact error message required).
65	v-Path	No Communication	DSP card does not respond	<ol style="list-style-type: none"> (1) Restart transmitter via >System< / >Service<. (2) Contact the NIVUS hotline (serial number and exact error message required).
66	v-Path	Value too high	Path check, measured value deviates significantly	<ol style="list-style-type: none"> (1) Check the connections on the cables / the transmitter and check the cables for damage. (2) Make sure that the cables have not been extended manually. (3) Check the parameterised offset values using the cable information. (4) Check whether the sensor position deviates from the parameterised position. (5) Contact the NIVUS hotline (serial number and exact error message required).
67	v-Path	Value too low	Path check, measured value deviates significantly	<ol style="list-style-type: none"> (1) Check the connections on the cables / the transmitter and check the cables for damage. (2) Make sure that the cables have not been extended manually. (3) Check the parameterised offset values using the cable information. (4) Check whether the sensor position deviates from the parameterised position. (5) Contact the NIVUS hotline (serial number and exact error message required).

#	Error Message		Cause of Error	Troubleshooting Measure(s)
68	v-Path	Invalid	Path check value invalid (from DSP card)	(1) Make sure that the sensors connected in pairs actually correspond to the same path in the installation. (2) Check all sensors and cables for visible damage. (3) Check the functionality (is a ringdown behaviour visible) of all sensors under >Application< / >Diagnostics< / >v-Path< / >Sensor Test<. (4) Check the parameterisation of the measurement place and the sensors in the system. (5) Restart transmitter via >System< / >Service<. (6) Contact the NIVUS hotline (serial number and exact error message required).

Tab. 11 List of Error Messages

Maintenance and Cleaning

WARNING***Disconnect the System from Mains Power***

Disconnect the unit from the mains and secure the higher system against being switched on again before starting maintenance.

Disregarding may lead to electric shock.

WARNING***Germ Contamination***

Due to the frequent use of the sensors in the waste water sector, parts can be contaminated with dangerous germs. Therefore, appropriate precautions must be taken when coming into contact with cables and sensors.

Wear protective clothing.

47 Maintenance

47.1 Maintenance Interval

The Type NivuFlow transmitter is virtually free of calibration, maintenance and wear by design. Nevertheless, NIVUS recommend an **annual check** of the entire measuring system by the NIVUS customer service.

Depending on the area of application of the measuring system, the maintenance interval may vary.

The scope of maintenance and its intervals depend on the following factors:

- Measurement principle of the sensors
- Material wear
- Measurement medium and channel hydraulics
- General regulations for the operator of the measurement system
- Environmental conditions

NIVUS recommends having the measurement system completely inspected by a company of the NIVUS group **after latest ten years**.

Generally the verification of instruments and sensors is a basic measure in order to improve operational reliability and to increase the lifetime.

47.2 Customer Service Information

For the recommended annual inspection of the entire measuring system or complete maintenance after ten years at the latest, contact our customer service:

NIVUS GmbH - Customer Centre

Phone +49 7262 9191-922

customercenter@nivus.com

48 Cleaning

48.1 Transmitter

WARNING



Disconnect the System from Mains Power

Make sure that the transmitter is disconnected from mains power.

Disregarding may lead to electric shock.



Important Notes

- The **blue plastic strips** of the DIN rail enclosures must not be removed for cleaning the enclosure.
- **Never wipe the terminal blocks or plug connections** with a damp cloth or similar.

If necessary, clean the transmitter enclosure with a dry lint-free cloth.

In case of heavier dirt, you can wipe the enclosure with a damp cloth. Do **not** use harsh cleaning agents or solvents. Instead, it is better to use mild household cleaners or soap suds.

48.2 Transducers

Be sure to follow the instructions for maintenance and cleaning of the sensors. These instructions can be found in the respective technical description or instruction manual.

The technical description or operating instructions are part of the sensor delivery or can be downloaded at www.nivus.com.

49 Dismantling/Disposal

Improper disposal may be harmful to the environment.

- ➡ Dispose of device components and packaging materials in accordance with the applicable local environmental regulations for electrical products:

1. Disconnect the device from mains power.
2. Disconnect connected cables on the front of the device with a suitable tool.
3. Remove the transmitter from the DIN rail.
4. Remove the buffer battery from the transmitter (see procedure described as follows) and dispose of it separately and properly.



EU WEEE Directive

This symbol indicates that the requirements of Directive 2012/19/EU on waste electrical and electronic equipment must be observed when disposing of the device. NIVUS GmbH support and promote the recycling or environmentally sound, separate collection/disposal of waste electrical and electronic equipment to protect the environments and human health. Observe the local laws and regulations on disposal.

NIVUS GmbH is registered with the EAR, therefore public collection and return points in Germany can be used for disposal.

The device is equipped with a buffer battery (lithium button cell) that must be disposed of separately.

➡ Procedure for removing the buffer battery (coin cell) on the removed transmitter:

1. If present, remove the four blue plastic strips (Pos. 1). These are plugged in and glued to the basic unit.

Info:

If the transmitter was installed in a field enclosure, these plastic strips are not present.

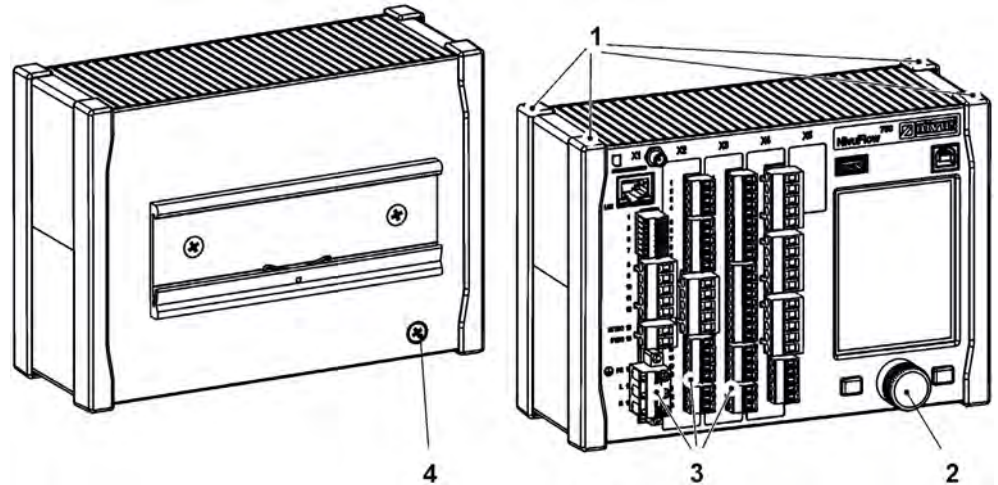

2. Remove the cover cap (Pos. 2) on the rotary pushbutton with a screwdriver or similar.
3. Loosen the fastening inside the rotary pushbutton with a screwdriver or similar.
4. Unscrew the countersunk screw M4x8 (Pos. 4) (for earthing/fastening) incl. serrated lock washer on the back of the housing.
5. Pull off the rotary pushbutton and existing connector strips (Pos. 3) from the front of the enclosure.
6. Unscrew 4x M3 Torx self-tapping screws on the front of the enclosure (previously covered by the plastic strips) and remove the front panel together with the circuit boards.



7. Remove the buffer battery (Pos. 5) mounted on the upper board.

50 Installation of Spare Parts and Accessories

We expressly draw your attention to the fact that spare parts and accessories which have not been supplied by us have also not been tested and approved by us.

The installation or use of such products may therefore negatively alter or invalidate the design properties of your measurement system.

NIVUS are expressly excluded from liability for damage caused by the use of non-original parts and non-original accessories.



You will find a selection of the accessories of the NIVUS GmbH in Chapter "51 Accessories".

51 Accessories

Article No	Description
<i>ZUB0 NFWx</i>	Field enclosure in different versions to protect the NivuFlow in outdoor areas
<i>BSL0 x</i>	Various overvoltage protection elements for power supply, sensors and data lines of the NivuFlow 600
<i>NFX0 LIZENZ REGL</i>	Device licence for activation: Q-Controller functionality
<i>NFX0 LIZENZ ERW</i>	Device licence for activation: transmission activation of the "Extended" data set
<i>NFX0 LIZENZ EXP</i>	Device licence for activation: transmission activation of the "Expert" data set
<i>NFX0 LIZENZ FTP</i>	Device licence for activation: remote data transmission via FTP and E-Mail (required if a customer SIM card is used)
<i>NFX0 LIZENZ PWDN</i>	Device licence for activation: clocked operation of permanent NivuFlow transmitters
<i>NFX0 LIZENZ MODB</i>	Device licence for activation: Modbus coupling of up to 3x NF5, NF6 and NF7 to one multi-measurement place device NF6....2
<i>ZUB0 ANT 4G LTE</i>	Magnetic base antenna, 2G/3G/4G, cable length 2.5m RG 174, connection SMA plug, 2dBi, antenna length approx. 10cm
<i>NLM0 EMATR 02</i>	Round antenna 2G/3G/4G, cable length 3 m RG174, connection SMA plug, for installation in dust pan or generally for installation on control cabinets (vandal-proof), for all units with SMA socket
<i>NLFO ANTENNE</i>	Rod antenna 2G/3G/4G, bendable, SMA plug
<i>ZUB0 ANT DL 89529</i>	Rod antenna 2G/3G/WLAN/4G, cable length 3m RG58, 3 dBi omnidirectional, LowMoss SMA plug, rod approx. 269 mm, incl. mounting angle for outdoor installation
<i>ZUB0 ANT VER Lx</i>	Extension cable RG174, 2G/3G/4G/5G, for all antennas with SMA plug, 2 dBi, various
<i>ZUB0 USB STICK</i>	USB stick for readout of parameter settings and readings using the NivuFlow USB interface
<i>ZUB0 ROUTER BOX0</i>	Router Box without power adapter
<i>ZUB0 ROUTER BOXN</i>	Router Box with power adapter
<i>ZUB-CO RA00xxx</i>	Fastening system clamp-on transit time sensors NIC-CO
<i>ZUB0 SB 50300</i>	2x Clamp band (stainless steel V2A) with quick lock; width 14.3 mm; length 1 m; clamping range 51...311 mm for DN50...250
<i>ZUB0 ME 3001000</i>	2x Metal band (stainless steel V2A); width 14 mm; Länge 5 m; incl. 2x clamping elements; for DN300...1000

ZUB0 ES x	2x stainless steel cable with clamping element, various
ZUB0 KOP x	Coupling pads, various
ZMS0 x	Mounting systems
NFE0 COMC x	Connection cable between transmitter and one extension module or between two extension modules, various
BSL0 EP 220-20	EnerPro 220 Tr / 20kA for power lines
BSL0 EP 220-5	EnerPro 220 Tr / 5kA for power lines
BSL0 EP 1-24	EnerPro 24-Tr, 20.000 A leakage current, high-performance surge arrester for power supplies
ZUB0 TT KABEL xx	Connection cable between pXT and transmitter, various
BSL0 DP 2X24/24	DataPro 2x1-24V/24V for 2-wire data lines, KDA sensors and i-Series sensors (Zone 1)
BSL0 DP 2X24/24 EX	DataPro 2x1-24V/24V for 2-wire data lines, ATEX approval Zone 1
BSL0 SPT 01	SonicPro T overvoltage protection for NIVUS transit time sensors; 1 protection element per 1 sensor; incl. 1 m connection cable to NF6xx transmitter or NFE Extension Module; for connection between NF6xx transmitter or NFE Extension module and sensor
BSL0 SPT 10	SonicPro T overvoltage protection for NIVUS transit time sensors; 1 protection element per 1 sensor; incl. 10 m connection cable to NF6xx transmitter or NFE Extension Module; for connection between NF6xx transmitter or NFE Extension module and sensor

Tab. 12 Accessories (selection) for the transmitter



Further information on spare parts and accessories can be obtained from your responsible distributor/agency or directly from the NIVUS GmbH.

Index

Symbole

>Browse< Function 115

A

Accessories 176
Accident Levels 15
Alarm
 Communication 147
Approvals 182
Article No..... 28

B

Backlight..... 150
Backup Battery 17, 174
Basic Menu 68
Basics
 Diagnostics..... 154

C

Calming Section 47
Cause of Error 169
CE Label 25
Certificates 182
Change Password 83
Commissioning Examples
 Clamp-On Sensors..... 69
 Wetted Sensors..... 70
Communication
 Alarm..... 147
 Data Transmission 143
 Modbus 148
 TCP/IP 140
 Web Server 141
Compress 120
Connections 12, 19
Contact Protection Measures 47
Control Elements..... 12, 13, 65
Copyrights 3
Customer Centre..... 173

D

Data Depth
 Expert..... 119
 Extended 119
 Standard..... 119
 USB Stick 119
Data Memory..... 27
Data Transmission
 Communication 143

Date/Time Selection 114
Device ID..... 25
Device Structure..... 23
Diagnostics
 Basics..... 154
 Flow Controller 160
 Inputs and Outputs..... 156
 Q-Controller..... 160
 Signal analysis 162
 Simulation 167
 v-Paths 155
Disclaimer 17
Display
 Overview 65
Disposal 174

E

Environmental Regulations 174
Error Messages 169
ESD Risks 33
EU WEEE Directive..... 174
Event Type
 Clock Control..... 126
Extension Module..... 52

F

File Format
 USB Stick..... 119
File Naming 122
Flow Controller
 Diagnostics..... 160

G

Germs 16, 173

H

Hotline 64
Humidity 21, 26

I

Input Correction..... 68
Inputs and Outputs
 Diagnostics..... 156
Inspection upon Receipt..... 21
Instruction Manual..... 21
Intended Use 18
Interfaces 14, 23

Transducers	27
Translation.....	3
Transmission Period	
USB Stick	118
Transport	21
Transport Damage	21
Trend Graph	76
Troubleshooting.....	169

U

Units System	132
Update NivuFlow	139
Use.....	18

V

Vibrations	21
v-Paths	
Diagnostics.....	155
v suppressed	
Low-Flow.....	95

W

Warning Notices	
on the Device	16
Web Server	
Communication	141

Open Source Software

52 List of Sources of the Licences and Codes used

The transmitter type NivuFlow uses code from the following open source projects:

- Freetype (<http://www.freetype.org>)
- Libharu (<http://libharu.org>)
- Libjpeg (<http://www.ijg.org>)
- Libpng (<http://www.libpng.org>)
- Zlib (<http://www.zlib.net>)
- Mini-XML (<http://www.msweet.org>)
- Nano-X/nxlib (<http://www.microwindows.org>)
- FLTK (<http://www.ftk.org>)
- Appendix1: LGPL
- Appendix2: MPL



Licensing Issues

For questions on licensing contact opensource@nivus.com

Approvals and Certificates

DE / EN / FR

EU Konformitätserklärung

*EU Declaration of Conformity**Déclaration de conformité UE*

Für das folgend bezeichnete Erzeugnis:

*For the following product:**Le produit désigné ci-dessous:*NIVUS GmbH
Im Täle 2
75031 EppingenTelefon: +49 07262 9191-0
Telefax: +49 07262 9191-999
E-Mail: info@nivus.com
Internet: www.nivus.de

Bezeichnung:	Durchflussmessumformer stationär NivuFlow 6xx
<i>Description:</i>	<i>permanent flow measurement transmitter</i>
<i>Désignation:</i>	<i>convertisseur de mesure de débit fixe</i>
Typ / Type:	NF6-...

erklären wir in alleiniger Verantwortung, dass die auf dem Unionsmarkt ab dem Zeitpunkt der Unterzeichnung bereitgestellten Geräte die folgenden einschlägigen Harmonisierungsvorschriften der Union erfüllen:

*we declare under our sole responsibility that the equipment made available on the Union market as of the date of signature of this document meets the standards of the following applicable Union harmonisation legislation:**nous déclarons, sous notre seule responsabilité, à la date de la présente signature, la conformité du produit pour le marché de l'Union, aux directives d'harmonisation de la législation au sein de l'Union:*

- 2014/30/EU
- 2014/35/EU
- 2011/65/EU

Bei der Bewertung wurden folgende einschlägige harmonisierte Normen zugrunde gelegt bzw. wird die Konformität erklärt in Bezug die nachfolgend genannten anderen technischen Spezifikationen:

*The evaluation assessed the following applicable harmonised standards or the conformity is declared in relation to other technical specifications listed below:**L'évaluation est effectuée à partir des normes harmonisées applicable ou la conformité est déclarée en relation aux autres spécifications techniques désignées ci-dessous:*

- EN 61326-1:2013
- EN 61010-1:2010 + A1:2019 + A1:2019/AC:2019

Diese Erklärung wird verantwortlich für den Hersteller:

*This declaration is submitted on behalf of the manufacturer:**Le fabricant assume la responsabilité de cette déclaration:***NIVUS GmbH**
Im Täle 2
75031 Eppingen
Germany

abgegeben durch / represented by / faite par:

Ingrid Steppe (Geschäftsführerin / Managing Director / Directeur général)

Eppingen, den 21.10.2022

Gez. *Ingrid Steppe*



NIVUS GmbH
Im Tæle 2
75031 Eppingen

Telefon: +49 07262 9191-0
Telefax: +49 07262 9191-999
E-Mail: info@nivus.com
Internet: www.nivus.de

DE / EN / FR

EU Konformitätserklärung

EU Declaration of Conformity

Déclaration de conformité UE

Für das folgend bezeichnete Erzeugnis:

For the following product:

Le produit désigné ci-dessous:

Bezeichnung:	Durchflussmessumformer stationär mit internem 2G/3G/4G Modem zur Datenfernübertragung NivuFlow 6xx
<i>Description:</i>	<i>Permanent flow measurement transmitter with internal modem for remote data transmission</i>
<i>Désignation:</i>	<i>Transmetteur de débit stationnaire avec modem intégré pour transmission de données</i>
Typ / Type:	NF6-...

erklären wir in alleiniger Verantwortung, dass die auf dem Unionsmarkt ab dem Zeitpunkt der Unterzeichnung bereitgestellten Geräte die folgenden einschlägigen Harmonisierungsvorschriften der Union erfüllen:

we declare under our sole responsibility that the equipment made available on the Union market as of the date of signature of this document meets the standards of the following applicable Union harmonisation legislation:

nous déclarons, sous notre seule responsabilité, à la date de la présente signature, la conformité du produit pour le marché de l'Union, aux directives d'harmonisation de la législation au sein de l'Union:

- 2014/53/EU
- 2011/65/EU

Bei der Bewertung wurden folgende einschlägige harmonisierte Normen zugrunde gelegt bzw. wird die Konformität erklärt in Bezug auf die nachfolgend genannten anderen technischen Spezifikationen:

The evaluation assessed the following applicable harmonised standards or the conformity is declared in relation to other technical specifications listed below:

L'évaluation est effectuée à partir des normes harmonisées applicable ou la conformité est déclarée en relation aux autres spécifications techniques désignées ci-dessous:

- EN 61010-1:2010 + A1:2019 + A1:2019/AC:2019
- EN 61326-1:2013
- Draft ETSI EN 301 489-52 V1.2.1
- EN 301 908-1 V15.2.0 (UMTS/3G, LTE/4G)
- EN 301 908-13 V13.2.1 (LTE/4G)
- EN 62311:2008
- EN 301 489-1 V2.2.3
- EN 301 511 V12.5.1 (GSM/2G)
- EN 301 908-2 V13.1.1 (UMTS/3G)

Diese Erklärung wird verantwortlich für den Hersteller:

This declaration is submitted on behalf of the manufacturer:

Le fabricant assume la responsabilité de cette déclaration:

NIVUS GmbH
Im Tæle 2
75031 Eppingen
Germany

abgegeben durch / represented by / faite par:

Ingrid Steppe (Geschäftsführerin / Managing Director / Directeur général)

Eppingen, den 21.10.2022

Gez. *Ingrid Steppe*